



PROGRAMMABLE MIDI MULTI-EFFECTS BASS PREAMP

USERS GUIDE



• WARNING •

To prevent electrical shock or fire hazard, do not expose this appliance to rain or moisture. Before using this appliance, read the operating guide for further warnings.

• CAUTION •

*Risk of electrical shock - **Do Not Open.***

*To reduce the risk of electrical shock, do not remove cover.
No user serviceable parts inside.
Refer servicing to qualified personnel.*



This symbol is intended to alert the user to the presence of important operating and maintenance (servicing) instructions in the literature accompanying the product.

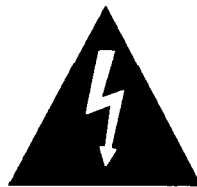

This symbol is intended to alert the user to the presence of uninsulated “dangerous voltage” within the product’s enclosure that may be of sufficient magnitude to constitute a risk of electrical shock.

Contents

| | | |
|------|---|----|
| 1.0 | INTRODUCTION AND SET-UP | 5 |
| 1.1 | INTRODUCTION | 5 |
| 1.2 | FEATURES | 5 |
| 1.3 | FRONT PANEL DESCRIPTIONS | 6 |
| 1.4 | BACK PANEL DESCRIPTIONS | 8 |
| 1.5 | CONNECTION DIAGRAMS | 9 |
| 1.6 | CONNECTING THE PRO-FEX II MIDI FOOT CONTROLLER | 11 |
| 1.7 | THE FIRST TIME YOU TURN IT ON | 11 |
| 1.8 | ADJUSTING THE INPUT AND OUTPUT LEVELS | 12 |
| 2.0 | USING THE BASS-FEX | 12 |
| 2.1 | BASS-FEX OPERATING INSTRUCTIONS | 12 |
| 2.2 | QUICK START | 12 |
| 2.2a | Preview the Sounds from the Front Panel | 12 |
| 2.2b | Preview the Sounds Using the Pro-Fex II Foot Controller | 13 |
| 2.3 | DEFINITIONS AND ABBREVIATIONS | 13 |
| 2.3a | Definitions | 13 |
| 2.3b | Abbreviations | 14 |
| 2.4 | PERFORMANCE WITH THE BASS-FEX | 15 |
| 2.4a | Play Mode | 15 |
| 2.4b | Setting Up Your Programs | 15 |
| 2.4c | Performance Parameter Control | 16 |
| 2.4d | Bypassing Individual Effects Using the Optional Foot Controller | 16 |
| 2.4e | Volume Control During Performance | 16 |
| 2.5 | EDITING SOUNDS | 16 |
| 2.5a | Overview | 16 |
| 2.5b | Creating a Custom Multi-effect Chain | 17 |
| 2.5c | Editing Individual Effect Parameters | 17 |
| 2.5d | Effect Level Control | 17 |
| 2.5e | MIDI Dynamic Effect Parameter Control | 18 |
| 2.5f | Comparing your Sounds to Other Presets | 19 |
| 2.5g | Storing your Preset | 19 |
| 2.6 | USING MIDI | 20 |
| 2.6a | Transmit and Receive Channels | 20 |
| 2.6b | MIDI Program Change and Bank Switching | 20 |
| 2.6c | MIDI Continuous Controllers | 21 |
| 2.6d | MIDI Volume Control | 21 |
| 2.6e | MIDI System Exclusive Remote Storage | 22 |
| 2.6f | Loading Sets or Presets to their original locations | 23 |
| 2.6g | Loading Sets or Presets to new locations | 23 |
| 2.6h | Remote Editing using MIDI System Exclusive | 23 |
| 2.7 | RAM CARTRIDGE | 24 |
| 2.7a | Initializing New Cartridges | 24 |
| 2.7b | Saving Presets on the Cartridge | 24 |
| 2.7c | Loading Presets from the Cartridge | 24 |
| 2.7d | Cartridge Battery | 24 |

| | |
|---------------------------------|----|
| APPENDIX A | 25 |
| INDIVIDUAL EFFECTS | 25 |
| APPENDIX B | 38 |
| SYSTEM EXCLUSIVE FORMAT | 38 |
| SYSEX Command Format | 38 |
| SYSEX Dump File Format | 39 |
| APPENDIX C | 40 |
| REMOTE EDITING VIA SYSEX | 40 |
| SPECIFICATIONS | 47 |
| MIDI IMPLEMENTATION SHEET | 48 |

1.0 INTRODUCTION AND SET-UP

1.1 INTRODUCTION

The BASS-FEX® is the result of advanced digital technology and acoustical research. State of the art sampling and processing circuitry provide extraordinarily clean sounding, full-bandwidth pre-amplification coupled with practically limitless effect combinations. The BASS-FEX is designed to be the “master” instrument preamp/effects processor.

A mono instrument input with input gain control is converted to 44.1 kHz, 16 bit, 64x oversampled digital audio. The signal is then processed by a 24-bit multi-effect processor. There are twenty-three effect types, from which up to eight can be used simultaneously. Many of these effects convert the mono signal into stereo. Also available are a moveable effects loop and a bi-amp effect, which allows different effects to be used on either the 2/LOW or 1/HIGH channels.

Stereo outputs and output level control are available on the rear panel, as are effect loop sends and returns. Effect loop returns can be patched back into the effects chain and can be summed in parallel with effects following the loop patch point. MIDI IN and OUT are also available. When used with the optional PRO-FEX® II MIDI Foot Controller, the BASS-FEX becomes the master MIDI control center for your other MIDI gear.

Each effect has independent output level control, and effects can be combined in series or parallel with each other. Effect parameters are adjustable during performance via MIDI Continuous Control commands (available on the Pro-Fex II Remote Foot Controller). Remote Effect editing and storage is also available via special MIDI System Exclusive commands.

The BASS-FEX comes with 128 excellent sounds programmed into Factory Preset Memory. These sounds are always available regardless of what changes you have stored in the 128 preset User Memory. A third bank of 128 presets is available when the optional RAM Cartridge is installed. To arrange your preset sounds in the best order for performance, two banks of 128 programs map to any preset. Regardless of location, any User, Factory, or Cartridge preset can be mapped into any bank of programs. A third program bank also becomes available with the RAM Cartridge.

The real power of the BASS-FEX is in the effects themselves. The BASS-FEX has the usual assortment of Delay, Chorus, and Reverberation effects. It also contains our highly acclaimed digital distortion and overdrive effects. As most players know, the real secret to great sounding distortion is equalization. That is why we offer four types of EQ that can be used simultaneously—and that’s not counting the built-in programmable EQs in the Overdrive and Distortion effects. There is also a speaker simulator effect which really shines when recording direct or playing guitar through a full-range system. Two independent pitch shifters can also be used simultaneously, and placed anywhere in the effects chain. Then, there are the extras: two types of exciter, envelope filter, stereo simulator, auto-pan, and more!

1.2 FEATURES

- Digital stereo multi-effects processor.
- Mono input with stereo outputs.
- Independent effects can be combined in series or parallel in any order to form multi-effect chains.
- Each effect has independent output level control.
- Dynamic effect parameter control via MIDI; eight controllers per preset.
- 128 Factory presets are always available.
- 128 User presets for storage of custom sounds.
- Two program banks will map any MIDI program to any preset for recall from the front panel or via MIDI.
- RAM cartridge slot.
- MIDI volume control.
- Programmable effects loop can be placed anywhere in the effects chain.
- 20 kHz bandwidth using 44.1 kHz sample rate.
- 16-bit, 64x oversampled A/D on the input; 24-bit multi-effect processing, 16-bit D/A output.
- 20 character by 2 line LCD display.
- “Speed” knob and +/-Inc and +/-Dec buttons for easy programming.

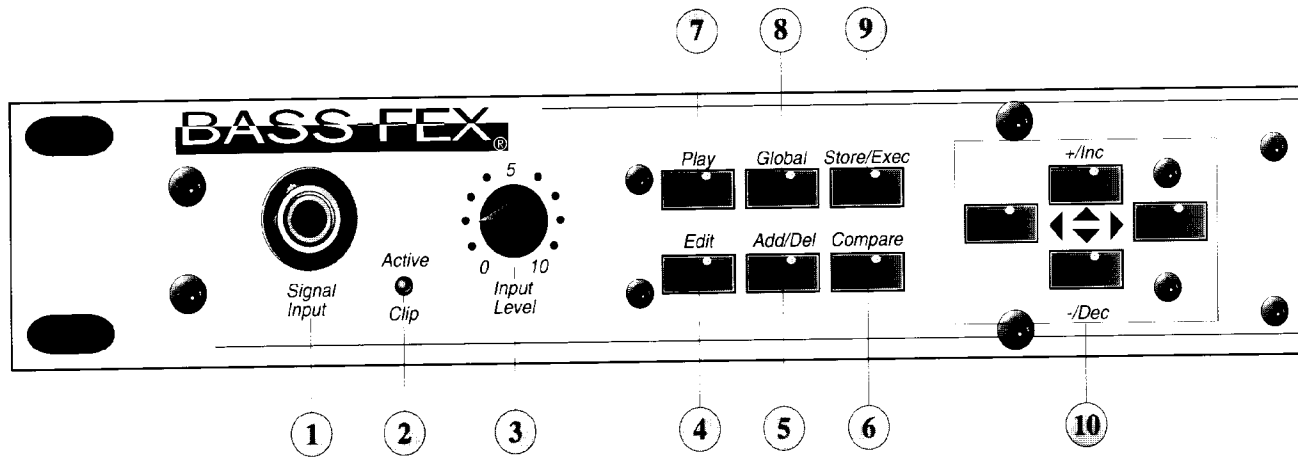

1.3 FRONT PANEL DESCRIPTIONS

1. Signal Input

This is used for line level input or instrument level signals.

2. Active Clip LED

This is a bi-color LED used to indicate normal activity and when clipping occurs. The LED will glow *green* during normal activity and will glow *red* when clipping occurs.

3. Input Level Control

This controls the input level coming into the processor. The control should be adjusted to a level that allows the *Active Clip LED* to glow *green*. If the *Active Clip LED* glows *red* the input level is too high and needs to be adjusted.

4. Edit Button

This button is used to access the editing functions for either constructing new presets or editing an existing one.

5. Add/Del Button

This button is used to “add” or “delete” effects from an effect chain.

6. Compare Button

This button is used to compare any stored preset with the preset currently being edited.

7. Play Button

This button is used to access the preset selections and program mapping.

8. Global Button

This button is used to access the view angle adjustment, gain adjustment, MIDI settings, and continuous controller assignments.

9. Store/Exec Button

This button is used to store changes to preset memory and to initiate system exclusive functions or store functions.

10. Arrow (Direction) Buttons

These buttons are used to navigate through the menus on the display: Left, Right, Up, or Down, and to increment or decrement selected values.

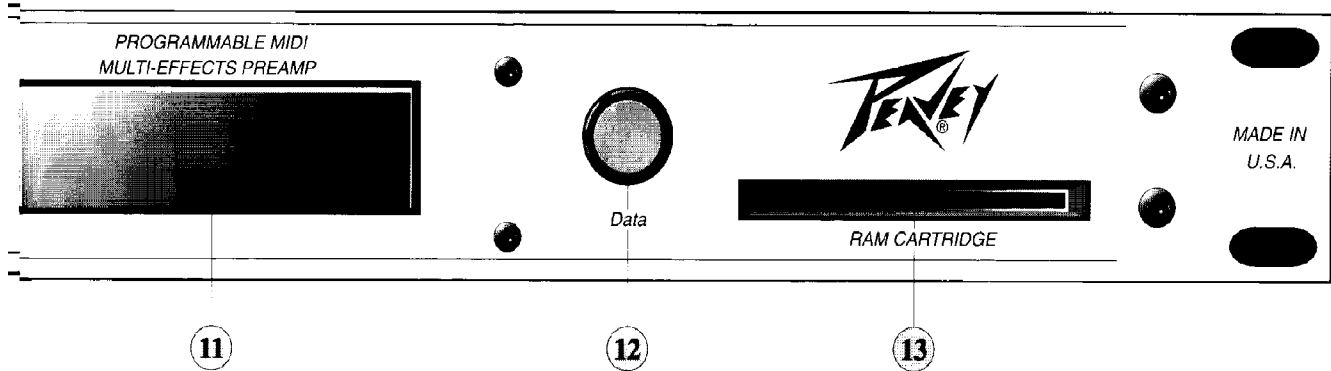

11. Display Window

20 character x 2 line Liquid Crystal Display (LCD) with variable view angle adjustment for easy visibility.

12. Data Knob

This is used to change effect parameters or to rapidly increase/decrease values.

13. RAM Cartridge

This is used to expand the number of programs (from 256 to 384), load programs into memory, and copy program from memory.



1.4 BACK PANEL DESCRIPTIONS

1. Output Level Control

This controls the overall signal level coming out of the 1/HIGH and 2/LOW outputs.

2. 1/HIGH and 2/LOW Signal Outputs

1/HIGH and 2/LOW outputs are provided for true stereo effects or a set of bi-amp high and low signals. For mono output operation, either output may be utilized.

3. 1 and 2 Effects Loop (Send)

This sends a mono signal from the BASS-FEX to an external effects processor.

4. 1/MONO and 2 Effects Loop (Return)

The 1/MONO and 2 effects loop returns accept stereo signals from external effects processors. If only one signal is being returned to the BASS-FEX, use the 1/MONO effects loop return.

5. MIDI In/Remote Switch Jack

This is an eight pin MIDI jack that accepts the standard five pin MIDI cable or a special eight pin cable used with the PRO-FEX™ II MIDI Controller. This jack is used to receive MIDI commands and system exclusive information from an external MIDI device.

6. MIDI Out/Thru Jack

This is used to transmit program changes and system exclusive information to an external MIDI device. This also provides the chaining of MIDI compatible devices. All data received at the MIDI In/Remote Switch jack is echoed, unaltered, to this jack except valid System Exclusive commands that the unit responds to.

Note: Since valid Program Change or Continuous Controller commands the unit receives will be transmitted out of the MIDI Out/Thru, care should be taken to avoid looping the output back to the input.

7. Power Supply

Use only the 16-16.5 volt AC 1000 mA adaptor provided. (Peavey part #00710160)

Caution: Use only the Peavey 16.5 volt power supply provided with this product. If the original power supply must be replaced, consult your Peavey dealer or the factory for the correct replacement. Failure to use the correct power supply could result in fire, shock hazard, extensive circuit damage, decreased performance, or non-operation.

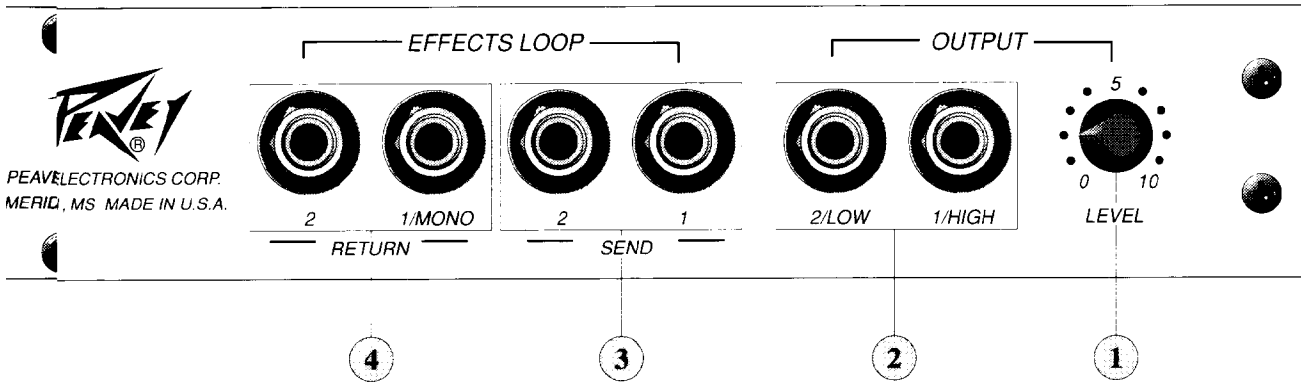

1.5 CONNECTION DIAGRAMS

There are several ways to connect the BASS-FEX into your instrument system. Shown here are some recommended hookups to give you optimal performance in some common situations.

1. Using the BASS-FEX with a separate amplifier and speakers.

This is a typical home, practice, or stage setup where the BASS-FEX is not directly connected into the P.A. system, but played through a separate amplifier and speakers.

BASS-FEX (Back)



Connect the *output* of the guitar, microphone, or other low level input source to the *input* of the BASS-FEX located on the front of the unit.

Connect the *1/HIGH* and *2/LOW* outputs of the BASS-FEX to channels one and two of the amplifier, respectively

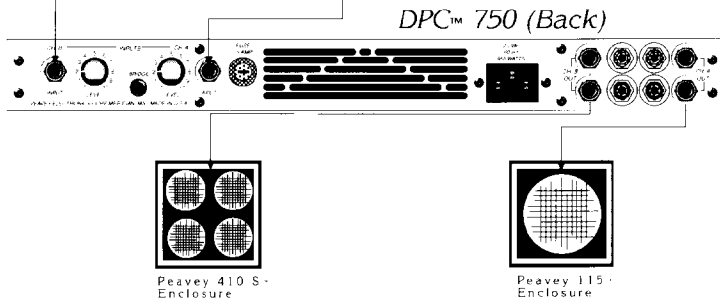

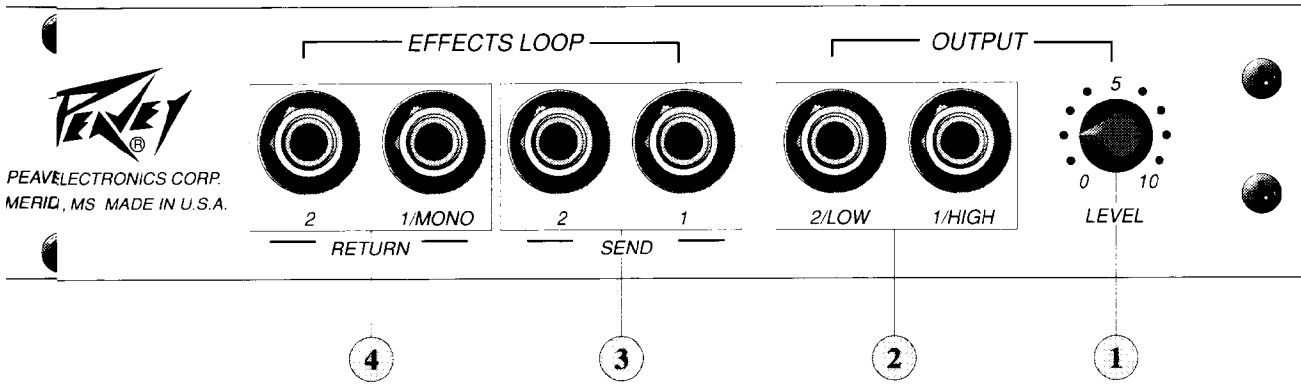

1.5 CONNECTION DIAGRAMS

There are several ways to connect the BASS-FEX into your instrument system. Shown here are some recommended hookups to give you optimal performance in some common situations.

1. Using the BASS-FEX with a separate amplifier and speakers.

This is a typical home, practice, or stage setup where the BASS-FEX is not directly connected into the P.A. system, but played through a separate amplifier and speakers.

BASS-FEX (Back)



Connect the *output* of the guitar, microphone, or other low level input source to the *input* of the BASS-FEX located on the front of the unit.

Connect the *1/HIGH* and *2/LOW* outputs of the BASS-FEX to channels one and two of the amplifier, respectively

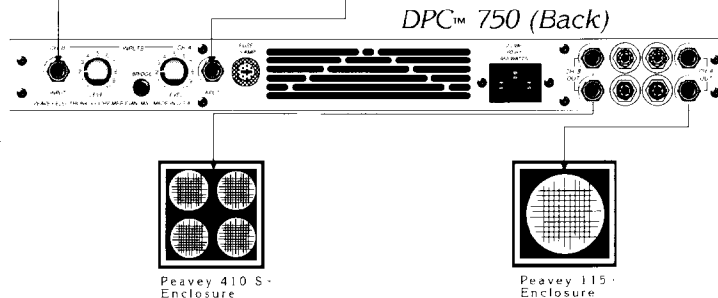

4. Direct connection to a mixing console.

When recording direct, or in some live situations, you can connect the outputs of the BASS-FEX directly into two channels of a mixing console. If you are using the BASS-FEX as a guitar preamp, you may want to experiment with building sounds using the Speaker Simulator effect.

BASS-FEX (Back)



Plug a guitar, microphone, or other low level input source into the front of the BASS-FEX.

Connect the *output* of the guitar, microphone, or other low level input source to the *input* of the BASS-FEX located on the front of the unit.

Connect the *1/HIGH* and *2/LOW* outputs of the BASS-FEX to any two channels of the mixer.

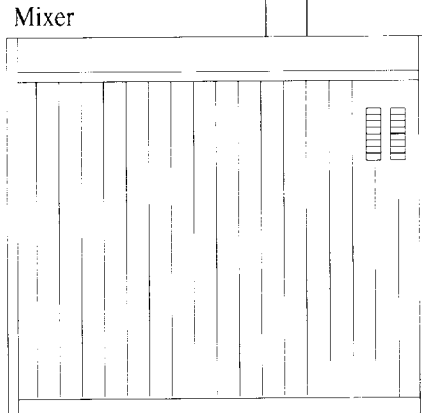

1.6 CONNECTING THE OPTIONAL MIDI FOOT CONTROLLER

BASS-FEX (Back)

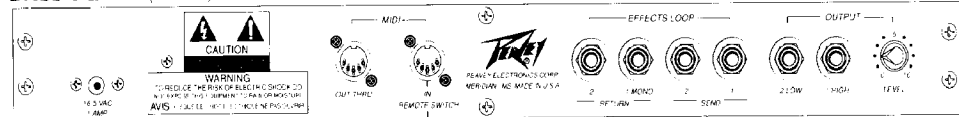

This is a special 15 foot 8 pin DIN cable - NOT a standard MIDI cable.

Connect the *MIDI/Remote Out* of the **PRO-FEX II MIDI Controller** to the *In/Remote Switch* of the BASS-FEX.

PRO-FEX II MIDI Controller (Back)



1.7 THE FIRST TIME YOU TURN IT ON

This procedure is recommended the first time your BASS-FEX is turned on after purchase from your Peavey dealer. This ensures that the memory is initialized and that the battery is fully charged.

WARNING: THE FOLLOWING PROCEDURE WILL OVERWRITE ALL CHANGES MADE TO THE UNIT'S MEMORY STORAGE, REPLACING THEM WITH FACTORY SETTINGS. ONLY PERFORM THE

FOLLOWING IF YOU DESIRE TO RE-INITIALIZE THE UNIT.

1. Unplug the unit from the power supply.
2. While holding both the *Play* and *Global* buttons on the front panel, power up the unit by plugging in the power supply.

The unit has now been initialized to factory settings. It is recommended that you leave the unit turned on for at least three hours at this time to ensure the battery has a full charge. The unit's battery should then last several years before replacement is required. The unit will warn you when the battery is getting low.

Battery replacement must be performed at an authorized Peavey Service Center.

1.8 ADJUSTING THE INPUT AND OUTPUT LEVELS

Once the connections are all made, set up the input and output levels of the BASS-FEX as follows:

Before turning anything on, set all level controls to **0**: input level control on the front of the BASS-FEX, output level control on the back of the BASS-FEX, and the input level control on your power amp (if it has one).

Next, turn the BASS-FEX on. Adjust the input level control on the front of the BASS-FEX while playing your instrument. The level should be set so that the *Active/Clip* LED just begins to turn red on your absolute loudest playing level.

Then turn on your power amp. Set the input level control on the amplifier to your normal playing level. No sound will be heard from it yet.

Finally, slowly adjust the output level control on the back of the BASS-FEX while playing until a suitable playing level is reached.

2.0 USING THE BASS-FEX

2.1 BASS-FEX OPERATING INSTRUCTIONS

The remainder of the manual is broken into several sections: Performance, Editing and Storage, Remote Operation via MIDI, Appendices describing each effect, and the unit's MIDI implementation. The first section is a Quick Start section which tells you how you can listen to the 128 great BASS-FEX factory sounds.

2.2 QUICK START

After connecting and adjusting the levels on the BASS-FEX, you may wish to preview the sounds before continuing on. This short section describes how you can quickly access each of the sounds and gives a brief description of some of the functions of the optional MIDI Foot Controller.

2.2a Preview the Sounds from the Front Panel

Pressing the *Play* button twice will always ensure you are in PLAY MODE. The cursor (short flashing underline) will be under the letter **A**, **B**, or **C** in the top left corner of the display. This letter indicates the PROGRAM BANK that is currently selected. (See section **2.4b Setting Up Your Programs**.)

```
A17  Dr9? NOT!! U17
CM→DL→CH→RU→PN
```

The number that immediately follows the Program Bank is the PROGRAM NUMBER. It is a number between 0 and 127. The name that follows the program number is the PRESET NAME. Following the preset name is a letter U, F, or C and the PRESET number. This is the PRESET currently being played. The letter indicates which PRESET MEMORY BANK this preset is stored in: U is for USER preset memory, F is for FACTORY preset memory, and C is for CARTRIDGE preset memory.

While the flashing cursor is under the program bank, turning the *Data knob* or pressing the *+Inc* or *-Dec* buttons will change the program being played. In this manner you can listen to each one of the 128 presets in the bank. Incrementing above program 127 or decrementing below program 0 will switch to the next program bank.

2.2b Preview the Sounds Using the Pro-Fex II Foot Controller

When you first turn the unit on with the foot controller plugged in, the display on the controller will show the program bank and number, the name of the preset being played, and the letters [PC] under MODE. The foot controller is in *Program Change* mode. In this mode, programs can be selected in sets of 10. There are twelve sets of 10 programs and one set of 8. Pressing the UP or DOWN buttons on the foot controller will change the set you are selecting from, then pressing any of the buttons labeled 0 to 9 will select a program within that set. For example, to select program 25, press the UP or DOWN button on the footswitch until the display shows:

```
-----  
A2-  Drg? NOT!! U17  
-----  
CM→DL→CH→RU→PN  
-----
```

Then press the button labeled 5. The BASS-FEX will immediately switch to program 25.

Another way you can step through each of the sounds using the foot controller is to press the MODE button on the foot controller until [FX] appears in the display under MODE. This is the *Effects* mode. Now the UP and DOWN buttons will step from one program to the next.

Notice that in EFFECTS mode, some of the LEDs on the footswitch will light up green. This indicates that certain effects can be bypassed from the footswitch by pressing the button associated with that effect. The LED will change to red to show that effect is bypassed.

2.3 DEFINITIONS AND ABBREVIATIONS

Before continuing on into the detailed operations of the BASS-FEX, it would be helpful to understand some terms used in describing functions and capabilities of the unit. Also presented here is a reference list of the abbreviations you'll be running across while programming the BASS-FEX.

2.3a Definitions

PRESET: This is the storage location of all PARAMETERS pertaining to the sound itself. The PRESET can be thought of as the effects chain, the settings for all effects in the chain, and the settings of all continuous controllers for that effects chain. Each PRESET has a name. There are two PRESET MEMORY BANKS in the BASS-FEX: FACTORY and USER. When new, the USER bank is identical to the FACTORY bank; however, as you make changes to the presets or create new presets from scratch, you will be saving these changes in the USER memory or the optional RAM Cartridge. While you can make changes to the presets in the FACTORY MEMORY, those changes can only be saved to locations in the USER memory or the CARTRIDGE. The FACTORY PRESETS will at all times be available, unchanged, as they came from the Peavey factory. When a RAM CARTRIDGE is installed, a third bank of 128 presets becomes available for play, editing, and storage.

PROGRAM: A PROGRAM is what changes when the BASS-FEX responds to a MIDI PROGRAM CHANGE command (such as those sent to the unit from the optional foot controller). Programs are merely pointers to Presets. This really comes in handy when setting up your performance. You can arrange your presets into sets and banks so that they can easily be recalled in playing order from the front panel, from the optional foot controller, or via MIDI. The BASS-FEX has two banks of programs inside it: Bank A and Bank B. Each has 128 programs in it, and each of these can be set to recall presets from either USER preset memory, FACTORY preset memory, or from the CARTRIDGE. The CARTRIDGE also provides a third PROGRAM BANK.

2.3b Abbreviations

Effect Types:

CM - Compressor
DS - Distortion
OD - Overdrive
CH - Chorus
DL - Delay
P1 - Pitch Shift 1
P2 - Pitch Shift 2
RV - Reverb
5B - 5 Band Graphic Equalizer
3B - 3 Band Sweep Mid Equalizer
4B - 4 Band Parametric Equalizer
CQ - 'Classic' Equalizer
PN - (Auto) Pan
EF - Envelope Filter
CT - Coil Tap
EX - Exciter
SS - Speaker Simulator
ST - Stereo Simulator
BI - Bi-amp
FX - Effects Loop

PARAMETERS

Ba, Bal - Balance
BP - Band Pass
BW - Bandwidth
C# - Control number
Ch - Channel
Env - Envelope
EXEC - Execute
Fb, Fdbk - Feedback
Flt - Filter
Fq, Freq - Frequency
Fst - Fast
L - Left
LP - Low Pass
Lvl - Level
NgT - Noise Gate Threshold

PD, Pdly - PreDelay
 Pram - Parameter
 R - Right
 Recv - Receive
 Re, Reson - Resonance
 Sh, Shft - Shift
 Sim - Simulator
 Slo - Slow
 Sn, Sens - Sensitivity
 Spkr - Speaker
 Xmit - Transmit
 Thr - Threshold
 TS - Tape Simulator

2.4 PERFORMANCE WITH THE BASS-FEX

2.4a Play Mode

Most of the time during performance, the BASS-FEX will be in the PLAY mode. The PLAY mode is accessed by pressing the *Play* button. The BASS-FEX also switches to PLAY mode each time it responds to a MIDI PROGRAM CHANGE command (such as those sent by the optional foot controller). A typical display for PLAY mode is shown below:

```

A17  Dry? NOT!! U17
CM→DL→CH→RV→PN
  
```

As described in the quick start section, the first letter **A** in the display (with the flashing cursor under it) indicates that the PROGRAM being played is in PROGRAMBANK A. The number following it is the PROGRAMNUMBER. The name is the name of the PRESET which that program points to. The **U** indicates that this preset is stored in USER PRESET MEMORY, and the number is the number of the preset.

On the bottom line of the display are the first six effects in the effect chain. (If the chain is longer than 6 effects, the others will not be shown. In this case, the chain is: **Compressor** in series with **Delay** in series with **Chorus** in series with **Reverb** in series with **Auto Pan**.

Note: Lower case letters indicate that the effect has been bypassed by the optional foot controller.

2.4b Setting Up Your Programs

Any program from any bank can call up any preset. In performance this is an extremely handy feature. To change which preset is called by the program currently selected, press the *Right Arrow* button so that the cursor is flashing under the PRESET NAME. Now use the *Data knob* or the *+/Inc* or *-/Dec* buttons to select the program you desire to have mapped to this preset. Changes are automatically stored, so this is all you have to do. Press the *Left Arrow* button to select the program, switch to the next program, and set it up by repeating the above steps.

When a RAM CARTRIDGE is installed, PROGRAMS in bank A or B can be programmed to point to PRESETS stored on the CARTRIDGE. If at a later time the cartridge is removed and this program is selected, the display will show:

```

A2   *NO CART*  C0
CM→3B→0D→RV
  
```

The sound being played will not change. You should replace the cartridge, or select a new preset for this program.

A third PROGRAM BANK is available on the RAM CARTRIDGE. When re-programming this bank, you must ensure that the CARTRIDGE WRITE PROTECT is disabled, otherwise you will get the following message:

```
CARTRIDGE  
WRITE-PROTECTED
```

The program will not change. For more information on the RAM CARTRIDGE see section **2.7 RAM CARTRIDGE**.

2.4c Performance Parameter Control

Most effects' parameters can be varied during performance via MIDI CONTROL CHANGE commands. These are available from the optional foot controller. Each preset can have up to eight parameters that respond to these changes. Most of the FACTORY presets are set up with controllers assigned to them (see the PLAYLIST). Set the mode of the foot controller to CONTROL CHANGE. [CC] will appear under MODE in the foot controller display. Select an active controller by pressing the button on the foot controller corresponding to the effect to be controlled.

2.4d Bypassing Individual Effects Using the Pro-Fex II Foot Controller

When the foot controller is in FX mode, LEDs on the controller indicate the available effects in the preset being played. If the LED is GREEN, that effect is turned on. If the LED is RED, that effect is bypassed. The play screen also indicates the bypassed effects by displaying the abbreviation for that effect in lower case letters. You can toggle the individual effect on and off using the foot controller by pressing the button corresponding to the effect you wish to switch.

2.4e Volume Control During Performance

The BASS-FEX will respond to MIDI VOLUME CHANGE messages (controller #7). These changes are global. That is, they effect the unit even after the program is changed. One of the two CV pedal jacks on the optional foot controller is assigned to MIDI VOLUME. A CV PEDAL plugged into this jack will act as a MIDI VOLUME pedal. You can re-assign the volume to a different control number if you wish. For example, if you want to assign volume to one of the ten general purpose controllers on the foot controller, see section **2.6d MIDI Volume Control**. Volume can also be controlled from the front panel, but this is not usually done during performance. Once again, see section **2.6d MIDI Volume Control**.

2.5 EDITING SOUNDS

2.5a Overview

When any sound is recalled in PLAY mode, it is copied into an EDIT BUFFER, then played from there. Therefore, any sound can be edited, regardless of which preset bank it is stored in. Any changes you make to the sound while editing can be heard as you make the changes, but these changes do not become permanent until you store them in the USER or CARTRIDGE preset memory.

When you press the *Edit* button while in play mode the BASS-FEX switches to CHAIN EDIT mode. The chain is displayed as a set of two letter abbreviations for each effect. A typical example is shown below:

For a complete description of each effect, see **Appendix A**.

When the cursor is on an effect, pressing the *+/Inc* or *-/Dec* buttons or turning the *Data knob* will switch that effect to another effect type. Pressing the *Edit* button will allow you to edit the parameters of that effect. When the cursor is on a path (arrow or plus sign) between two effects, pressing the *+/Inc* or *-/Dec* buttons or turning the *Data knob* will switch the path between series and parallel and back. Pressing the *Edit* button will allow you to change the effect output levels.

2.5b *Creating a Custom Multi-effect Chain*

The first step to creating a custom preset is selecting an existing preset that is similar to it, then changing, adding, or deleting effects until you have the chain you desire. The next step is to edit the parameters of the effects in the chain.

Recall a preset in PLAY mode as described previously. Press the *Edit* button to edit the chain. Delete unwanted effects by placing the cursor under the effect and pressing the *Add/Del* button. You can change effects to another type by placing the cursor under the effect and turning the *Data knob* or pressing the *+/Inc* or *-/Dec* buttons. You can add new effects in the chain by placing the cursor on the PATH INDICATOR (arrow or plus sign) between any two effects and pressing the *Add/Del* button. Effects can also be added at the beginning and end of the chain in the same manner. You can change the path between two effects. An arrow means that the two effects are in series, a plus sign indicates that the two effects are in parallel. With the cursor under the path indicator, the *+/Inc* and *-/Dec* buttons or the *Data knob* will change the path.

If you are using a BI-AMP to split the right and left channels into separate effect chains, the left path is on the upper line and the right path is on the lower line. Incrementing the cursor past the last effect on the upper line will move it down to the first effect on the lower line.

2.5c *Editing Individual Effect Parameters*

Each effect type has one or more parameters that control the sound of that effect. (See Appendix A for effect details.) To edit the individual effect's parameters, place the cursor under the effect you wish to edit and press the *Edit* button once. The value of the first parameter and the effect name will appear on the top line of the display. A list of abbreviated effect parameters appear on the bottom line. The cursor will be flashing under the first parameter. Using the *+/Inc* or *-/Dec* buttons or the *Data knob* will change the value of the parameter. Using the *Right* or *Left Arrow* buttons will move the cursor to other parameters for editing.

2.5d *Effect Level Control*

By placing the cursor under the path between any two effects and pressing the *Edit* button, you will be able to control the output levels of each effect block.

You may now adjust the output level of the effect immediately preceding the cursor position as shown:

```
[COMPRESSOR]
Output Level= 100
```

Using the *Data knob* or the *+/Inc* or *-/Dec* buttons, vary the effect level until the desired level is attained. You can use the *Right* or *Left Arrow* buttons to switch between the various effect output levels in the chain. When done adjusting the levels, press the *Edit* button again to return to the chain edit screen.

2.5e MIDI Dynamic Effect Parameter Control

MIDI dynamic parameter control introduces a vast variety of expression possibilities. This could include changing delay or reverb times, EQ frequencies or gains, effect levels, and many other parameters in real time with any MIDI continuous controller. Each preset in the BASS-FEX has eight selectable controls. These controllers can be assigned to any variable parameters of the available effects within the preset. The MIDI continuous controllers are stored along with the preset.

To edit and assign parameters to continuous controllers, you will use the CNTRL menu. If you are in any edit mode and press the *Global* button, the CNTRL menu will appear. If you are in PLAY mode, then you will have to push the *Global* button several times until the CNTRL menu appears. A typical CNTRL screen is shown below:

```
DISTN Drive [CNTRL]
#1 Pram C# Ch Sc
```

The first number shows which of the eight controllers you are editing. With the cursor flashing under this number, you can use the *+/Inc* or *-/Dec* buttons or the *Data knob* to view each of the eight controller assignments.

Pressing the *Right Arrow* button one time moves the cursor under the word PRAM. The *+/Inc* or *-/Dec* buttons or the *Data knob* can now be used to select the parameter to be controlled by this controller. Parameters for each of the effects in the chain will appear in turn.

Note: If a controller was previously assigned to an effect type that has been deleted from the chain, the controller will still be assigned to that parameter, but will have no effect on the sound. This feature allows you to experiment with different effects in the chain without having to re-assign the controllers each time.

Placing the cursor under **C#** on the bottom line allows you to assign a particular MIDI CONTINUOUS CONTROLLER to this parameter. The available controllers are numbers 1 - 120.

The optional MIDI foot controller transmits GENERAL PURPOSE MIDI CONTINUOUS CONTROLLERS assigned to each of the effect footswitches. The controller number for each switch is as follows:

| <u>Button:</u> | <u>CC#</u> | <u>Button:</u> | <u>CC#</u> |
|----------------|------------|----------------|------------|
| COMPRESSOR | / 0 = 16 | REVERB | / 5 = 80 |
| DIST/OVDR | / 1 = 17 | PITCH | / 6 = 8 |
| EQ | / 2 = 18 | ENV FILTER | / 7 = 82 |
| CHORUS | / 3 = 19 | EXCITER | / 8 = 83 |
| DELAY | / 4 = 20 | EFX LOOP | / 9 = 84 |

CV jack 1 transmits controller 7 (Volume) and CV jack 2 transmits controller 6 (Data Controller).

Press the *Right Arrow* button again. The cursor is flashing under **Ch** for CHANNEL. Each controller may be assigned to receive on any of the sixteen MIDI channels or OMNI. The unit defaults to all controllers set to the unit's RECEIVE (RECV)

channel in the MIDI menu.

SC is the MIDI Parameter Control Scale Factor. This allows the control range to be adjusted from full range to some percentage of full range.

Here's how the Scale Factor works: MIDI continuous controllers output a value between 0 and 127. The BASS-FEX centers these values around 64 so that, with a scale factor of 100%, a controller output of 0 = -100%, 64 = 0%, and 127 = +100%.

| | | | |
|-----------------|-------|----|-------|
| MIDI Value: | 0 | 64 | 127 |
| BASS-FEX Value: | -100% | 0% | +100% |

To understand what the Scale feature can do, it is important to understand how continuous controllers affect the parameters to which they are assigned. In the BASS-FEX continuous controllers vary individual parameters about their programmed value. For example: Reverb mix is variable from 0 to 100. Let's say the mix is set to 50 in the current preset. If a continuous controller is assigned to this parameter, it will vary it about that nominal value. A MIDI controller value of 64, which is the middle of the range of controller values, will correspond to the programmed value for that parameter in the preset (in this case 50). Controller values above or below 64 will change the value of the affected parameter accordingly. The amount of change is controlled by the Scale factor. The Scale factor is a percentage of the total range of values for a specific parameter, and may be set from 0% to 100%. For instance, in the case of the Reverb mix parameter (which has a range of 0 to 100), a scale factor of 30% would allow a maximum change of plus or minus 30, since 30% of 100 is 30. With the parameter set to 50, it could be varied from 20 (50 - 30) to 80 (50 + 30). MIDI controller value 0 would result in a mix level of 20, MIDI controller value 64 would result in a mix level of 50 (the programmed value, MIDI controller value 127 would result in a mix level of 80, and all values between 0 and 127 would be scaled accordingly.

Setting the Scale factor to a negative number flips the controller output so that increasing controller values decreases the value of the controlled parameter.

2.5f Comparing your Sounds to Other Presets

While in any edit mode, a Compare mode is available which will allow comparison between the presets currently being edited and any one of the factory or user presets. Pressing the *Compare* button will toggle in and out of compare mode. Pressing the *+/Inc* or *-/Dec* buttons or the *Data knob* will allow you to select any preset to compare against. You can now use the *Compare* button to toggle back and forth between the sound you are editing and the chosen preset.

2.5g Storing your Preset

Press the *Store/Exec* button and the store display will appear.

```
-----  
STORE [Dry? NOT!! ]  
TO U1? Dry? NOT!!  
-----
```

Press the *Right* or *Left Arrow* buttons until the cursor is under the first letter of the preset name (in brackets).

Using the *+/Inc* or *-/Dec* buttons and/or the *Data knob*, change the preset name.

Once the preset name is what you want, you will need to store the preset in a preset location. To do this press, the *Right* or *Left Arrow* button until the cursor is under the preset number.

Use the *+/Inc* or *-/Dec* buttons or the *Data knob* to select the new preset location.

Note: If you do not want to store your changes over the existing preset, press the *Edit* or *Play* buttons at this time to abort the store command.

Press the *Store/Exec* button to store the new preset. The display will briefly show:

```
STORE COMPLETE  
TO U17 Dry? NOT!!
```

2.6 USING MIDI

There are four major functions that can be performed via MIDI on the BASS-FEX: change Programs/Banks; change effect parameters during performance via Continuous Controller messages; store presets on remote storage devices via MIDI SYSTEM EXCLUSIVE messages; and remotely edit and store any user accessible parameter using special Remote Editing SYSEX messages. The BASS-FEX can also be setup to transmit MIDI PROGRAM CHANGE messages when a new program is selected from either the front panel or via MIDI.

2.6a Transmit and Receive Channels

MIDI messages are transmitted and received on one of sixteen different MIDI channels. The unit can be set to transmit messages on any of these channels, and to respond to valid incoming messages on any one or all sixteen channels. To change the channel the unit receives on, press the *Global* button until the MIDI menu appears as below:

```
Recv Ch=1 [MIDI]  
RC TC TP DP LP DS LS
```

The cursor is flashing under **RC** for Receive Channel. Use the *+Inc* or *-Dec* buttons or the *Data knob* to select MIDI channel one to sixteen or OMNI. OMNI will cause your unit to respond to valid MIDI commands received on any channel.

To change the MIDI channel the unit transmits on, press the *Right Arrow* button. The cursor is now flashing under **TC** for Transmit Channel. Use the *+Inc* or *-Dec* buttons or the *Data knob* to select the desired MIDI transmit channel.

To turn the TRANSMIT PROGRAM CHANGE feature on or off, use the *Right* or *Left Arrow* buttons to position the flashing cursor under **TP** for Transmit Program change. Use the *+Inc* or *-Dec* buttons or the *Data knob* to turn this feature on or off. When on, Transmit Program change will send a MIDI Program Change message out on the transmit channel each time the program is changed either from the front panel or via MIDI (including changes sent from the optional MIDI foot controller).

The other functions on the MIDI menu are SYSTEM EXCLUSIVE functions and are described in the section on SYSTEM EXCLUSIVE REMOTE STORAGE. (See section 2.6e.)

2.6b MIDI Program Change and Bank Switching

The BASS-FEX will respond to valid MIDI Program Change and Bank Select messages received on the unit's receive channel. Program changes will cause the unit to recall a program within the program bank currently selected. There are two banks of 128 programs in the unit's memory, bank A and bank B. A third bank, C, becomes available when the optional RAM Cartridge is installed. Program banks can be changed on the front panel by incrementing the program above 127 or below 0 while in PLAY mode, or by sending a MIDI Bank Select message to the unit.

The format of the MIDI BANK SELECT message is:

B0 00 00 20 00/01/02

(all numbers in hexadecimal)

where:

B0 00 = MIDI continuous controller 0 (bank select)
00 = bank high byte (always 0)
20 = MIDI 2 byte data indicator
00/01/02 : 00 selects bank A, 01 selects bank B, 02 selects bank C

A MIDI Bank Select command will tell the unit to switch to a program in the new bank the next time the program is changed either via MIDI PROGRAM CHANGE or from the front panel.

To set up the Program to Preset map, see section **2.4b Setting Up Your Programs**.

2.6c MIDI Continuous Controllers

Many of the factory presets in the BASS-FEX have MIDI continuous controllers assigned to them. The controller assignments are set up to take advantage of the General Purpose Controller messages transmitted by the optional MIDI foot controller. Continuous controllers make temporary changes to effect parameters depending upon the value of the controller message received. These changes are only made in the Effects Processor and not in Preset memory or the edit buffer. Continuous controllers are not intended for sound editing, but only for variation during performance. For a description of how to assign controllers to effect parameters, see section **2.5e MIDI Dynamic Effect Parameter Control**. For a list of controller assignments of the factory presets, see the PLAY LIST.

2.6d MIDI Volume Control

The BASS-FEX responds to MIDI VOLUME (controller 7) commands on its receive channel. You may turn this function on or off, change the controller that volume responds to, change the response scale, or manually change the global volume level. These functions are performed from the VOLUME menu under the *Global* button.

Press the *Global* button several times until the VOLUME menu appears as below:

```
VOLUME= 100 [VOL]
midi:OFF #7 SC=+50
```

With the cursor flashing under the volume level, use the *+Inc* or *-Dec* buttons or the *Data knob* to adjust the volume. This volume level affects all presets and remains the same even while changing from one preset to another. That's why we refer to it as the GLOBAL volume.

To turn the MIDI VOLUME feature on, press the *Right Arrow* button to move the cursor under MIDI:OFF on the bottom line of the display. Use the *+Inc* or *-Dec* buttons or the *Data knob* to turn MIDI VOLUME on or off.

To change the controller number to which the volume responds, place the cursor under the # sign on the bottom line, and use the *+Inc* or *-Dec* buttons or the *Data knob* to select a new controller number.

The MIDI SCALE can change the range of volume affected by the controller. A scale of +50 provides full range control. To vary this, place the cursor under SC for SCALE and use the *+Inc* or *-Dec* buttons or the *Data knob*.

2.6e MIDI System Exclusive Remote Storage

The BASS-FEX can utilize MIDI SYSTEM EXCLUSIVE (SYSEX) to store and re-load presets on a remote MIDI storage device such as a Peavey MIDI Librarian™, MIDI Streamer™, DPM® 3, or other sequencer or computer equipped with MIDI and the appropriate software. The BASS-FEX can dump ALL the user presets, SETS of ten presets, or INDIVIDUAL presets. When re-loading sets or individual presets, they can be loaded back to where they originated or into any other set or preset location. Presets can even be re-loaded directly into the edit buffer.

MIDI SYSEX functions are in the MIDI menu under the *Global* button. Press the *Global* button several times until the MIDI menu appears.

```
Recv Ch=1      [MIDI]
RC TC TP DP LP DS LS
```

To dump a single preset to an external storage device (or another BASS-FEX), press the *Right* or *Left Arrow* button until the cursor is under **DP** (dump preset).

```
Dump Prst U1 →EXEC+
RC TC TP DP LP DS LS
```

Use either the *+/Inc* or *-/Dec* buttons or the *Data knob* to select the preset(s) (0-127, All, or Edit Buf) to be dumped. Press the *Store/Exec* button to execute the dump. The display will briefly show:

```
SYSEX DUMP
in progress
```

Note: The MIDI transmit channel of the BASS-FEX must be set the same as the MIDI receive channel on the external device unless the external device is set to Omni.

The BASS-FEX can also dump sets of presets. The sets are arranged as follows:

| | |
|--------|---------|
| Set 0 | 0-9 |
| Set 1 | 10-19 |
| Set 2 | 20-29 |
| Set 3 | 30-39 |
| Set 4 | 40-49 |
| Set 5 | 50-59 |
| Set 6 | 60-69 |
| Set 7 | 70-79 |
| Set 8 | 80-89 |
| Set 9 | 90-99 |
| Set 10 | 100-109 |
| Set 11 | 110-119 |
| Set 12 | 120-127 |

To dump a set of presets to an external device (or another BASS-FEX): In the MIDI Channel/Sysex display press the *Right* or *Left Arrow* button until the cursor is under **DS** (dump set).

```
-----  
Dump Set  U1  →EXEC+  
RC TC TP DP LP DS LS  
-----
```

Use either the *+/Inc* or *-/Dec* buttons or the *Data knob* to select the set (0-12) to be dumped. Press the *Store/Exec* button to execute the dump. The display will briefly show:

```
-----  
          SYSEX DUMP  
          in progress  
-----
```

Note: The MIDI transmit channel of the BASS-FEX must be set the same as the MIDI receive channel on the external device unless the external device is set to Omni.

2.6f Loading Sets or Presets to their original locations

To load sets or presets to their original locations from an external storage device or another BASS-FEX, set the receive MIDI channel to match the send MIDI channel on the external storage device, or BASS-FEX. Then send the sets or presets to the BASS-FEX. That's all there is to it!

Note: See the owners manual of the storage device for instructions on sending MIDI dumps.

2.6g Loading Sets or Presets to new locations

To load sets or presets to a new location set the receive MIDI channel to match the send MIDI channel on the external storage device or BASS-FEX. Then select LP (load preset) if loading a preset to a new location or LS (load set) if loading a set to a new location. Select the new location. Then send the preset or set to the BASS-FEX.

Note: The MIDI receive channel of the BASS-FEX must be the same as the channel the data was originally transmitted on. An error message will appear if they are not the same. If this occurs, set the receive channel to the channel shown in the message and transmit again.

2.6h Remote Editing using MIDI System Exclusive

A set of special system exclusive editing commands is available on the BASS-FEX. This will allow remote programming of all effect parameters, effect levels, the effect chain, and continuous controller assignments. The edit buffer can also be stored in any USER preset location remotely. These changes can be heard immediately, but will not appear on the screen unless the parameter being edited is currently selected. **APPENDIX C** contains complete remote editing command information for programmers of remote editing devices or software.

2.7 RAM CARTRIDGE

The optional RAM Cartridge acts as a memory extension for the storage of 128 additional PRESETS and 128 additional PROGRAMS. Presets can be accessed individually, and played directly off the RAM Cartridge without the need to move them into internal USER memory. The 128 additional programs appear as program bank C and can be set up to point to any preset in Cartridge, User, or Factory preset memory.

2.7a Initializing New Cartridges

RAM Cartridges are sold separately by your PEAVEY Dealer. Ask for the *Cache Card 32* part #71023. When new, cartridges must be initialized for use with the BASS-FEX. To do this, select the CART menu under the *Global* button. Place the cursor under **In** for initialize, and press the *Store/Exec* button.

WARNING: INITIALIZING THE RAM CARTRIDGE WILL OVERWRITE ALL CURRENT DATA ON THE CARTRIDGE WITH THE USER PRESETS.

2.7b Saving Presets on the Cartridge

Presets may be stored individually to the Cartridge by using the normal store procedure, or all USER presets may be SAVED on the cartridge by using the SAVE User->Cart function on the CART menu. This function also writes PROGRAM BANK A into the PROGRAM BANK C as well, converting all pointers to USER PRESETS into pointers to CARTRIDGE PRESETS in the process.

2.7c Loading Presets from the Cartridge

Cartridge presets may be recalled individually from the cartridge to the edit buffer, or ALL presets may be LOADED to USER preset memory by using the LOAD Cart->User function on the CART menu. This function also writes PROGRAM BANK C into PROGRAM BANK A, converting all pointers to CARTRIDGE PRESETS into pointers to USER PRESETS in the process.

2.7d Cartridge Battery

Most cartridges have a replaceable backup battery which maintains memory storage while the cartridge is removed from the unit or the unit is turned off. The battery will last from two to five years depending on the model. If the battery becomes low, the unit will warn you by periodically displaying the following screen:

```
-----  
                CAUTION  
                Cart. Battery Low  
-----
```

Note: If this message is displayed you should back up your cartridge data immediately, then replace the battery and restore the backed up data to the cartridge.

APPENDIX A

INDIVIDUAL EFFECTS

Compressor

The Compressor effect suppresses high input levels while boosting small signal levels as the input decreases. The result is a more consistent output volume and increased sustain.

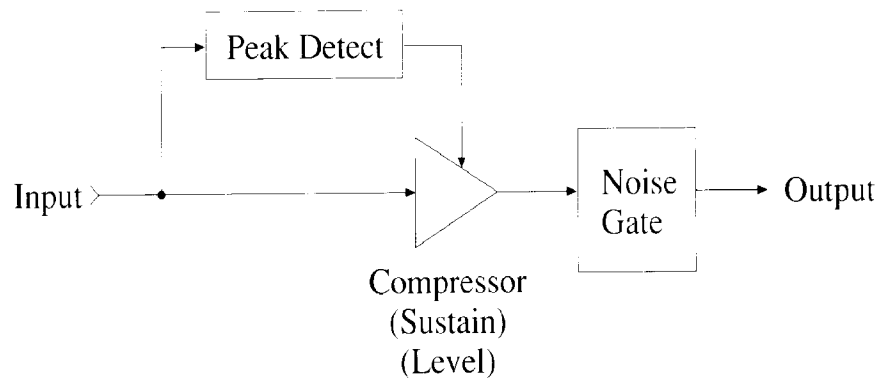

Parameters

- Attack:* The *Attack* parameter adjusts the speed at which the compressor responds to increases in signal level. Range is from extra slow to extra fast.
- Release:* The *Release* parameter adjusts the time for the output signal to decay. Setting the release to extra fast results in a very rapid decay, while setting the release to extra slow results in a very slow decay.
- Sustain:* Seven levels of sustain vary the maximum amount of gain that can be achieved by the compressor at various signal levels. Range 0 - 6.
- Level:* The *Level* parameter adjusts the maximum output of the compressor. Range is from 0 - 100%.
- Noise Gate:* At low signal levels, a compressor's gain may be very high, thus raising the level of noise output when no signal is present. Ten levels of noise suppression are available on the output.

Distortion

The *Distortion* effect consists of a distortion followed by an equalizer section. *Distortion* is a mono effect.

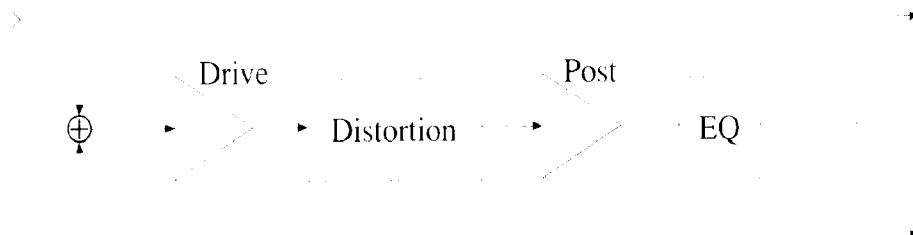

Parameters

- Fat:* The *Fat* parameter controls the low frequency gain. Parameter range -50 to 50.
- Edge:* The *Edge* parameter controls the high frequency gain. Parameter range -50 to 50.
- Body:* The *Body* parameter controls the mid frequency gain. Parameter range -50 to 50.
- Shift:* The *Shift* parameter is used to select the center point of the mid frequency range. The shift frequency is adjustable from 300 Hz to 900 Hz in 10 Hz increments.
- Resonance:* The *Resonance* parameter adjusts the bandwidth of the mid frequency range. Parameter range 0.1 to 4.9.

Overdrive

The Overdrive effect consists of an overdrive type distortion. Overdrive is a mono effect.

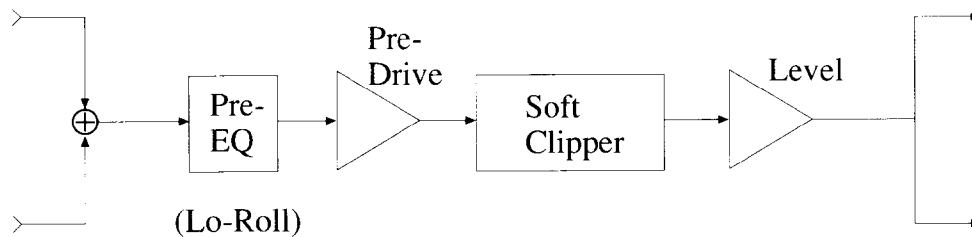

Parameters

- Low Rolloff:* The *Low Rolloff* parameter is used to adjust the tonality by rolling off the low frequencies in 100 Hz increments to 1900 Hz. The range of the low roll off is Normal and 0.1 to 1.9.
- Pre Drive:* The *Pre Drive* parameter is a gain control with a range from 1 to 10 which is used to overdrive the signal.
- Clip:* The *Clip* parameter is a “soft-clipping” control which provides increased sustain. Reducing the clip level increases the sustain. Range 0 - 99.

Note: As clip level is reduced, the overall output level of the overdrive is reduced. Therefore, very low clip levels will require a large increase in output volume. This can greatly decrease the dynamic range of the effect and increase noise.

- Level:* Adjusts the output level of the Overdrive effect. Range 0 - 100%.

- Fat:* The *Fat* parameter controls the low frequency gain. Parameter range -50 to 50.
- Edge:* The *Edge* parameter controls the high frequency gain. Parameter range -50 to 50.
- Body:* The *Body* parameter controls the mid frequency gain. Parameter range -50 to 50.
- Shift:* The *Shift* parameter is used to select the center point of the mid frequency range. The shift frequency is adjustable from 300 Hz to 900 Hz in 10 Hz increments.
- Resonance:* The *Resonance* parameter adjusts the bandwidth of the mid frequency range. Parameter range 0.1 to 4.9.

Overdrive

The Overdrive effect consists of an overdrive type distortion. Overdrive is a mono effect.

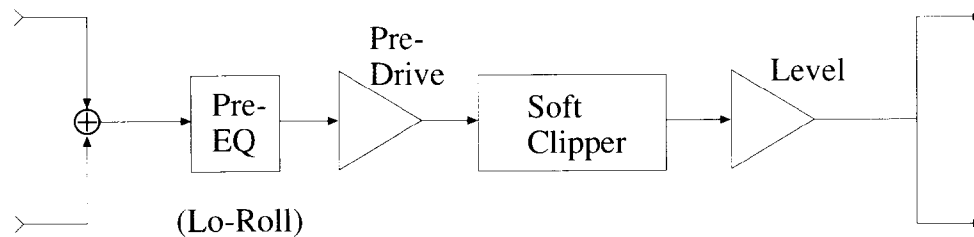

Parameters

- Low Rolloff:* The *Low Rolloff* parameter is used to adjust the tonality by rolling off the low frequencies in 100 Hz increments to 1900 Hz. The range of the low roll off is Normal and 0.1 to 1.9.
- Pre Drive:* The *Pre Drive* parameter is a gain control with a range from 1 to 10 which is used to overdrive the signal.
- Clip:* The *Clip* parameter is a “soft-clipping” control which provides increased sustain. Reducing the clip level increases the sustain. Range 0 - 99.

Note: As clip level is reduced, the overall output level of the overdrive is reduced. Therefore, very low clip levels will require a large increase in output volume. This can greatly decrease the dynamic range of the effect and increase noise.

- Level:* Adjusts the output level of the Overdrive effect. Range 0 - 100%.

Delay

The BASS-FEX offers three types of delays: Stereo, Tapped, and Mono. The delay can either be set to a fixed delay time or to a variable delay time that adjusts to match a MIDI clock. The fixed delay time is set in milliseconds with a range of 0-361ms when using the stereo delay and 0-724ms when using the mono or tapped delay. When the BASS-FEX is connected to a MIDI system, such as a sequencer, that generates MIDI clock messages, the delay time can be set so that the delay equals the period of 0-64 clks. So, for example, the delay time is set to 24 clks, the delay would be 1 quarter note long. Adjusting the delay below the 0ms setting accesses the MIDI clock feature.

Stereo Delay

A true stereo delay with delay times from 0 to 64 clks if using the MIDI sync feature or 0 to 361 ms if using a normal delay.

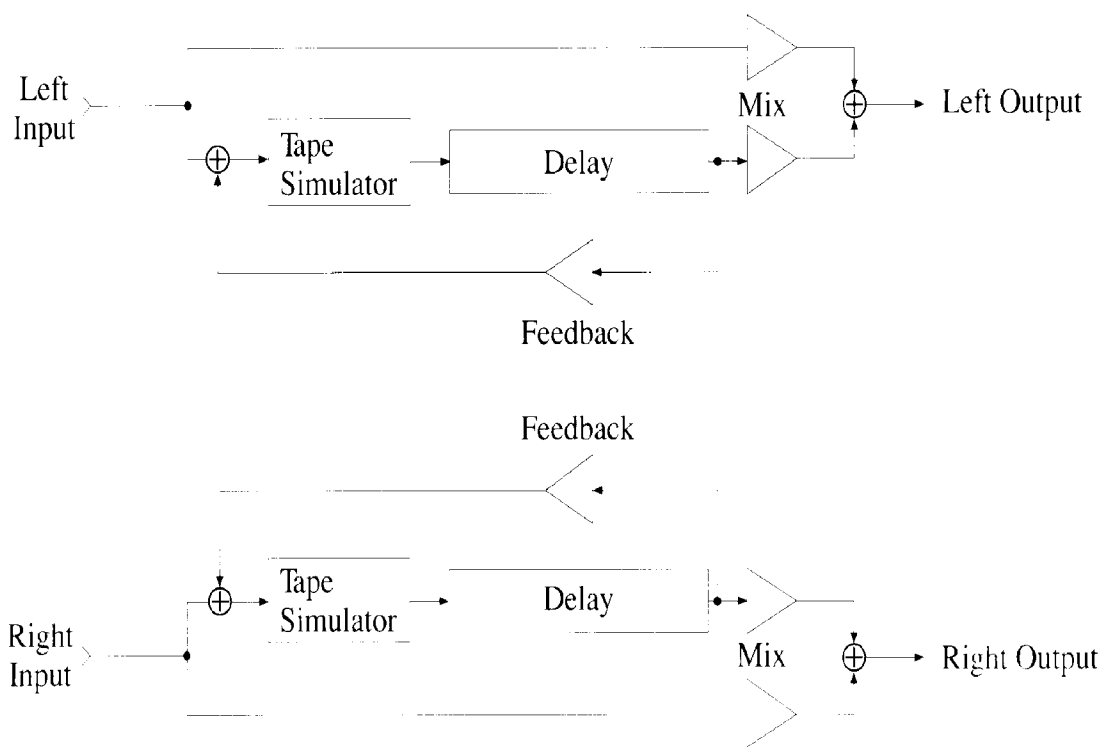

Parameters

- Left Delay:** Used to select the amount of delay on the 1/HIGH channel 0-64 clks; 0 - 361 ms.
- Left Feedback:** Used to select the amount of delay feedback on the 1/HIGH channel. This generates a repeating or echoing sound 0 - 99%.
- Right Delay:** Used to select the amount of delay on the 2/LOW channel 0-64 clks; 0 - 361 ms.
- Right Feedback:** Used to select the amount of delay feedback on the 2/LOW channel. This generates a repeating or echoing sound 0 - 99%.
- Tape Simulator:** This is used as a low pass filter before the signal is put through the feedback circuit. This feature is used to simulate a warmer, more realistic room sound. Range 1K, 2K, 4K, 8K, OFF.
- Mix:** Used to set the direct/effect mix of the delay effect. Range -100 to +100.

Tapped Delay

This delay creates a stereo delay from a mono source. The range is from 0 to 64 clks if MIDI sync feature and 0 to 724 ms if using a normal delay.

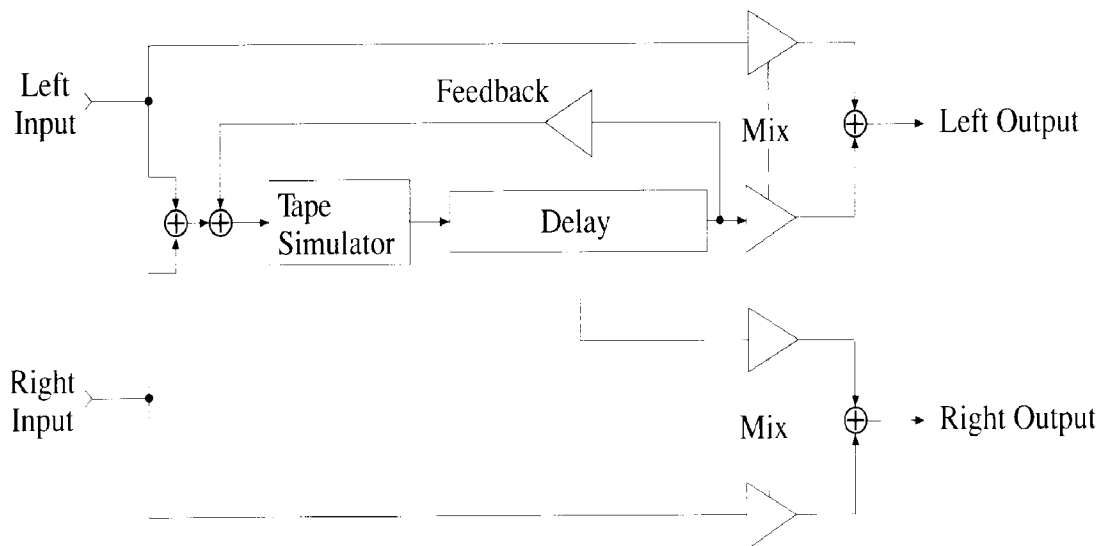

Parameters

- Left Delay:* Used to select the amount of delay on the 1/HIGH channel. Range 0 to 64 clks or 0 to 724 ms.
- Right Delay:* Used to select the amount of delay on the 2/LOW channel. Range 0 to 64 clks or 0 to 724 ms.
- Feedback:* Used to select the amount of delay feedback. Feedback is always taken from the longest delay output. Range 0-99%.
- Tape Simulator:* This is used as a low pass filter before the signal is put through the feedback circuit for gain enhancement. This feature is used to simulate a warmer, more realistic room sound.
- Mix:* Used to set the direct/effect mix of the delay effect. Range -100 to +100.

Mono Delay

A Mono delay with delay times ranging from 0 to 64 clks if using the MIDI sync feature or 0 to 724 ms if using a normal delay.

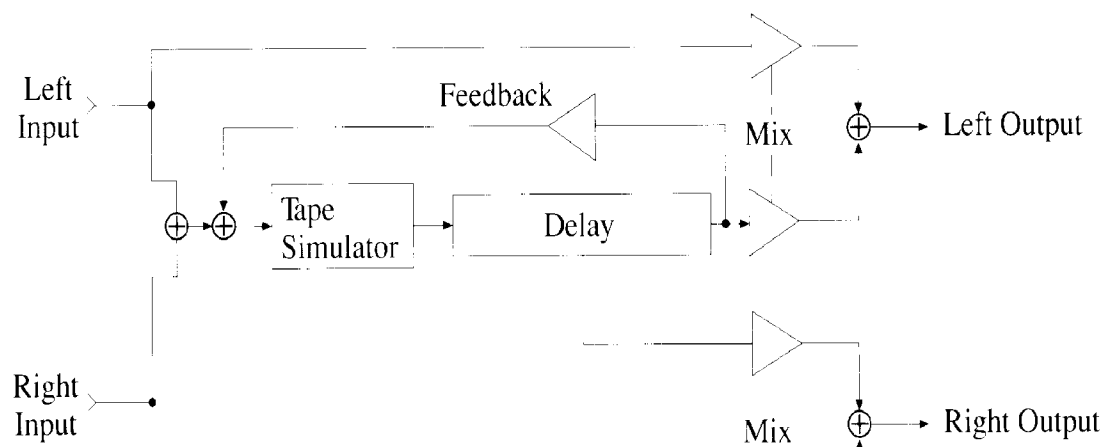

Parameters

- Delay:* Used to select the amount of delay. Range 0-64 clks or 0 to 724 ms.
- Feedback:* Used to select the amount of delay feedback. Feedback is always taken from the longest delay output. Range 0-99%.
- Tape Simulator:* This is used as a low pass filter before the signal is put through the feedback circuit. This feature is used to simulate a warmer, more realistic room sound. Range 1K, 2K, 4K, 8K, OFF.
- Mix:* Used to set the direct/effect mix of the delay effect. Range -100 to +100.

Pitch 1 and Pitch 2

In order to allow stereo pitch shifting, yet still have a pitch shifter available which does not use a large amount of effect space, we have developed a pitch shift effect with a panning input and independent left and right mix control. This effect is the only one that can be used in two locations in the chain simultaneously, thus allowing true stereo and independently controllable pitch shifting on each channel.

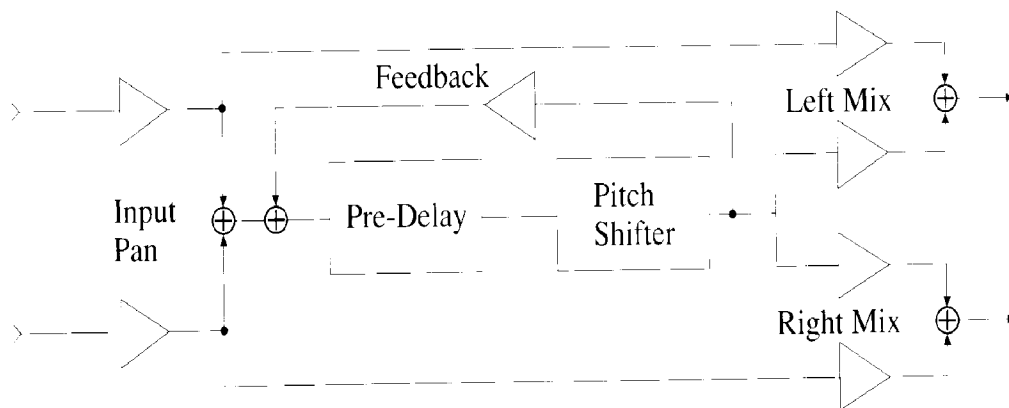

By placing two pitch shifters in parallel or series, and setting their inputs and mix levels panned to opposite sides, independent stereo detuning will be available.

Parameters

- Input:* The *Input* parameter controls the left/right input pan.
- PreDelay:* Up to 46 milliseconds of delay can be set before the pitch transposition begins. This creates a doubling or chorusing type sound.
- Pitch:* The *Pitch* parameter is used to select large amounts of transposition in half step increments. The range of the *Pitch* parameter is -12 to +12 (1 octave).
- Cents:* The *Cents* parameter is used to fine tune the transposed pitch when necessary. The range is -50 to +50. (1/2 step is 100 cents)
- Feedback:* The *Feedback* parameter controls the amount of output signal that is sent back to the input of the *PreDelay*. This can be used to create climbing or descending pitch type. Range 0-99%
- Left Mix:* The *Left Mix* parameter controls the direct/effect mix to the output of the effect for the 1/HIGH output channel. Range 0 - 100%.
- Right Mix:* The *Right Mix* parameter controls the direct/effect mix to the output of the effect for the 2/LOW output channel. Range 0 - 100%.

Reverb

The versatile stereo Reverb effect contains eight types of reverb, each with fully adjustable parameters.

Types

- Plate:** The Plate reverb produces a smooth reverb similar to that achieved with plate-reverbs.
- Tunnel:** The Tunnel reverb produces the many echoes associated with the acoustics of a tunnel.
- Spring:** The Spring reverb simulates the reverb produced by a spring reverb machine.
- Room:** The Room reverb has the ambience of a live room.
- Stage:** The Stage reverb has the ambience associated with a club stage.
- Hall:** The Hall reverb has the reverberation ambience associated with a concert hall.
- Gated:** A Gated reverb is a smooth rolling reverb that cuts off sharply rather than decaying away.
- Reverse:** A Reverse gated reverb builds from a quiet attack to a sharp decay, giving the impression of an instrument sound being played in reverse.

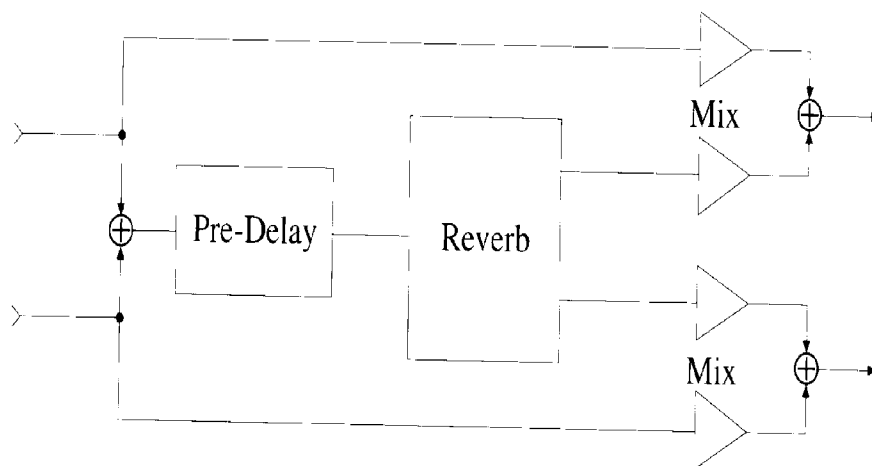

Parameters

- Size:** The *Size* parameter determines the size of the reverb being used. Parameter range is Small, Medium, Large, Huge.
- PreDelay:** The *PreDelay* parameter determines the amount of delay that is to be added before the reverberations begin. Range 0 to 46 ms.
- Time:** The reverb time of each reverb can range from 0 to 30 seconds. For Gated and Reverse types, the range is from 25 to 365 ms.
- Damping:** The *Damping* parameter controls the tonality of the reverb being produced. The setting range is 125 Hz to 8 kHz and Off. A low setting (250 Hz) results in high frequency reverberations being decayed very quickly; higher settings (4 kHz, 8 kHz, or Off) allow the high frequencies to continue on in the reverberation.
- Mix:** The *Mix* parameter controls the direct/effect mix at the output of the effect. The range is 0 to 100%.

Classic EQ

The Classic Equalizer effect is a sweepable mid EQ used on many guitar amplifiers.

Parameters

Low: The *Low* parameter controls the level of the low frequency range. The level can be adjusted from 0 to 100.

Mid: The *Mid* parameter controls the level of the mid frequency range. The level can be adjusted from 0 to 100.

Shift: The *Shift* parameter is used to select the center of the mid frequency. Range is 0 to 100.

High: The *High* parameter controls the level of the high frequency range. The level can be adjusted from 0 to 100.

5-Band Graphic Equalizer

The 5-Band Graphic Equalizer effect is a full stereo, five-band EQ with +/-12 dB gain on each frequency band, allowing emphasis or de-emphasis of any of the five bands. The center frequencies of the five bands are as follows: 40 Hz, 160 Hz, 660 Hz, 2.6 kHz, 10 kHz.

3-Band EQ with Sweepable Mid

The 3-Band Sweepable Mid EQ effect is a standard stereo EQ with +/-12 dB of gain on each frequency band.

Parameters

Type: Guitar, Voice, Drastic.

Low Gain: The *Low Gain* parameter adjusts the gain of the low frequency band parameter. Range is -50 to +50.

Mid Frequency: The *Mid Frequency* parameter is used to select the center frequency of the Mid Frequency band. The range is 99 Hz to 3.3 kHz.

Mid Gain: The *Mid Gain* parameter adjusts the gain of the mid frequency band parameter. Range is -50 to +50.

High Gain: The *High Gain* parameter adjusts the gain of the high frequency band parameter. Range is -50 to +50.

4-Band Parametric EQ

The Parametric Equalizer is a four band stereo equalizer with individually adjustable center frequencies, bandwidths, and gains for each of the four bands.

Parameters

Band: The *Band* parameter is used to select any one of the four bands. After a band has been selected, the frequency, bandwidth, and gain setting may be made for that particular band.

Frequency: The *Frequency* parameter is used to select the center frequency point of each band. Range is 20 Hz to 16 kHz.

Bandwidth: The *Bandwidth* parameter determines the width of the band from 1 octave to 1/100 of an octave.

Gain: The *Gain* parameter adjusts the gain of the band. Depending upon the particular setting, the gain can be used to emphasize (+dB) or de-emphasize (-dB) the particular band. Ranges from -24 dB to +12 dB.

Hum Filter

The Hum Filter effect is effective in removing the A.C. line noise from a signal.

Parameter

Frequency: The *Frequency* parameter selects between 60 Hz (U.S.A.) and 50 Hz (European) A.C. line frequencies.

Coil Tap

The Coil Tap effect is a special digital filter which can be used to emphasize or de-emphasize harmonics.

Parameters

Frequency: When the phase parameter is set to a positive number, the Frequency parameter controls the amount of harmonics being emphasized. Range is 1 to 10.

Phase: The *Phase* parameter is used to select the emphasis or de-emphasis of harmonics. Setting the Phase to a positive number will emphasize harmonics, while setting the Phase to a negative number de-emphasizes the harmonics. Range -100 to +100.

Exciter

The Exciter effect uses a “distortion technique” to add harmonics. Using this technique does not, in fact, result in a distorted sound, but instead produces an exciter effect.

Parameters

Drive: The Drive parameter setting determines the amount of harmonics added. The range is 0 (no harmonics) to 100 (maximum harmonics).

Tune: The Tune parameter controls the amount of emphasis. The range is from 0.1K (excites lower frequencies) to 4.9K (excites higher frequencies).

Type: The Type parameter is used to select between three different distortion types which produce three different sounds. Type 1 adds even harmonics, Type 2 adds odd harmonics, Type 3 adds even and odd harmonics.

Balance: The Balance parameter is used to set the balance between excited (100) and direct (0).

Envelope Filter

The Envelope Filter effect is an amplitude modulated filter. As the input signal level to the envelope filter changes, the filter frequency changes. This effect is sometimes referred to as an “automatic wah.”

Parameters

Sensitivity: The *Sensitivity* parameter is used to adjust the sensitivity to changing input signal levels. If the sensitivity is set to a positive number, then the filter frequency will increase with a rising input. If sensitivity is negative, then frequency decreases with a rising input level. Range -100 to +100.

Frequency: The *Frequency* parameter adjusts the starting point of the filter frequency. From there the filter will sweep up or down (depending on sensitivity) as the playing level changes frequency ranging from 2K to 5K, respectively. When the sensitivity is positive, the frequency values correspond to the frequency

range 100 Hz to 2 kHz.

Resonance: When the Bandpass filter type is selected, the *Resonance* parameter is used to adjust the width of the Bandpass filter (1 is narrowest, 100 is widest). When the Lowpass filter is selected, Bandwidth adjusts the steepness of the filter cutoff.

Type: The *Type* parameter is used to select the filter type. There are two filter types: Bandpass and Lowpass.

Mix: The *Mix* parameter is used to control the direct/effect mix at the output of the effect. Range is 0 to 100%.

Auto Pan

The Auto Pan effect is used to pan the output signal between the 1/HIGH and 2/LOW outputs. The panning rate and depth are both user selectable. The Auto Pan is a stereo effect.

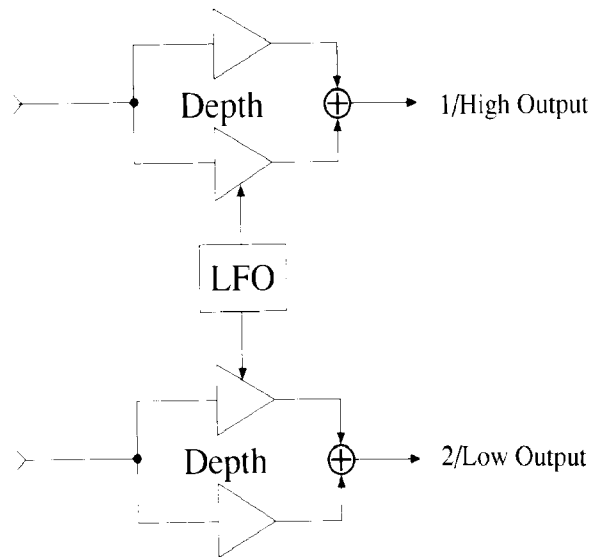

Parameters

Rate: The *Rate* parameter is used to select the speed at which the signal pans between the two outputs. The range is from 0.0 Hz to 99.9 Hz.

Depth: The *Depth* parameter determines the amount of signal being panned. Selecting a depth setting of 10% would yield a less defined pan, and setting the depth to 90% would result in a deep panning from side to side.
Range 0-100%

Speaker Simulation

The BASS-FEX has four stereo speaker simulation curves:

Scorpion Open: Simulates the frequency response of the Peavey Scorpion speaker in an open backed cabinet.

Scorpion Closed: Simulates the frequency response of the Peavey Scorpion speaker in a closed backed cabinet.

412 cabinet: Simulates the sound of four 12" speakers in a single cabinet.

British: Simulates the frequency response of a well known British manufacturer's guitar speaker setup.

These speaker simulation curves are convenient for both live performance and recording applications where the guitar is directly connected to a mixing console.

Stereo Simulator

A transverse filter approach is used to simulate stereo separation of a mono signal. The resulting signal is fed into a comb filter and the output and input is summed in the right channel and subtracted from the left channel. The resulting output simulates stereo separation of frequency bands. TUNE adjusts the distance between the separated frequency bands. There is a LowPass filter which, when on, will keep the bass centered between the two channels. The DEPTH of the stereo separation is variable from 0 - 100 percent.

Parameters

LowPass: The *LowPass* parameter is a lowpass filter which, when on, will keep the bass centered between the two channels.

Tune: The *Tune* parameter adjusts the distance between the separated frequency bands. Range is 100 Hz to 500 Hz.

Depth: The *Depth* parameter is the depth of the stereo separation. Range is 0 to 100.

Noise Gate

The Noise Gate effect is a downward expander.

The Peak level is determined by the input signal plus attack and decay variables which set the speed at which the peak can change.

Parameters

Attack Time: The *Attack Time* parameter is used to remove sharp attack transients. The larger this number the longer the attack will take to open the gate once closed. Range 0 to 99.

Release Time: The larger this number the longer it will take for a decaying signal to drop below the threshold. Range 1 to 99.

Threshold: The *Threshold* parameter sets the level in dB below digital clipping that the gate will begin to close. Range -2 to -90 dB.

Sensitivity: This determines the peak level below threshold that the gate will be fully closed. Range 1 - 9.

Effects Loop

The movable effects loop appears just as any other effect and can be placed anywhere in the effects chain. The sends are mono and are available from two jacks at the back of the unit. The returns are in stereo, and this stereo signal may be SUMMED in stereo with the output from the DSP after the last effect in the chain. The signal returning to the DSP is summed to mono, then added to the stereo DIRECT signal. This signal is then passed on to the next effect in the chain.

Note: When a MONO signal is returned, plug the signal into the 1/MONO effects return jack. This ensures that 100% of the return signal is summed back into the A/D converter.

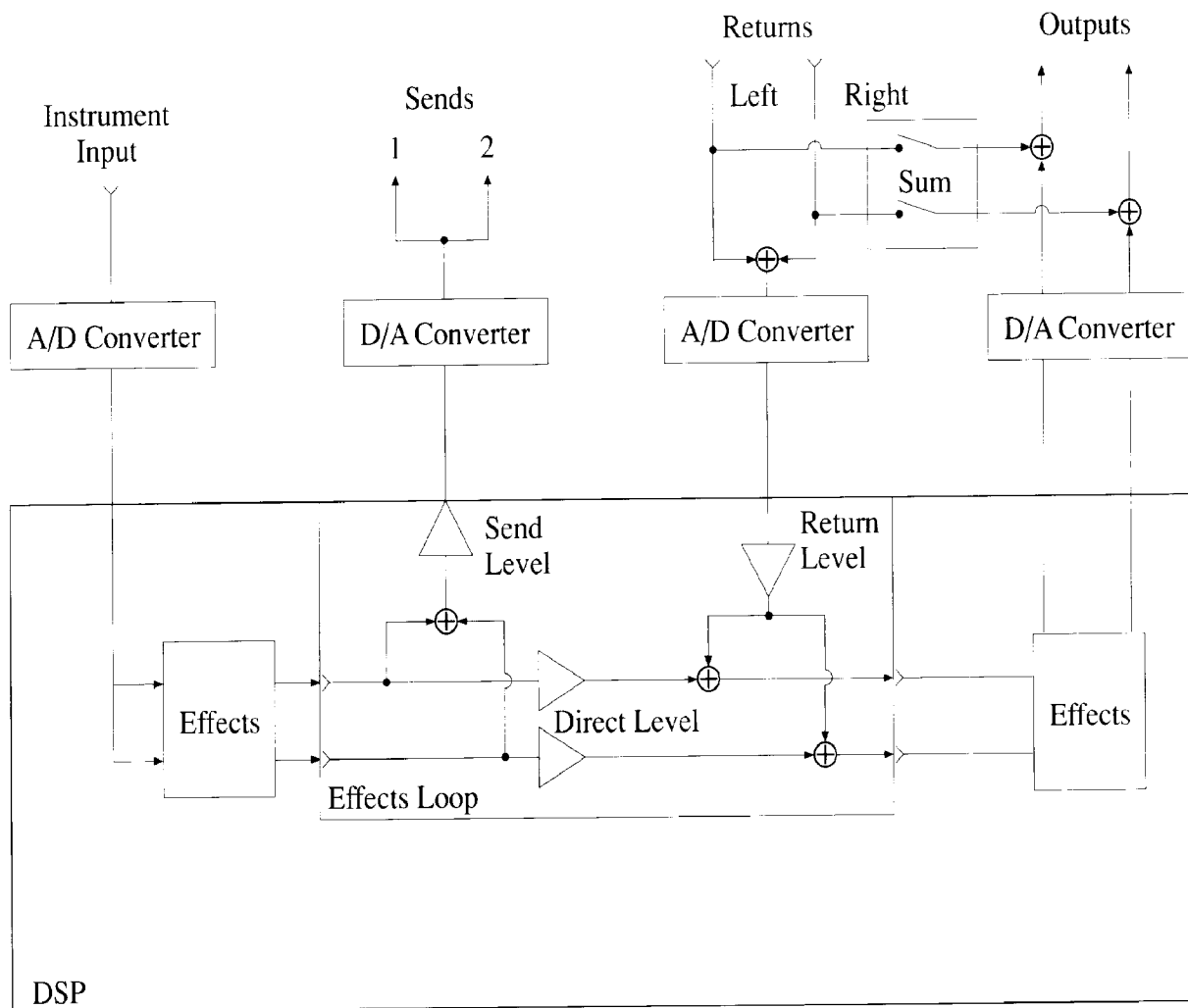

Parameters

- Send Level:* The level of the signal that is sent to the SEND jacks. Range 0 to 100.
- Direct Level:* The level of the direct signal that is mixed with the input from the effect loop returns. Range 0 to 100.
- Return Level:* The level of the signal that is returned to the effects chain.
- SUM:* This turns on and off an analog switch that sums the stereo returns with the analog output from the digital effects.

Bi-amp

The bi-amp effect enables you to split the stereo signal into two separate chains, placing different effect types on each chain. The signal following the bi-amp is MONO and only appears on one channel. Therefore, note that the signal on the TOP path (output 1) only passes through the TOP half of effects following the bi-amp, and the signal on the BOTTOM path (output 2) only appears on the BOTTOM channel of effects following the bi-amp.

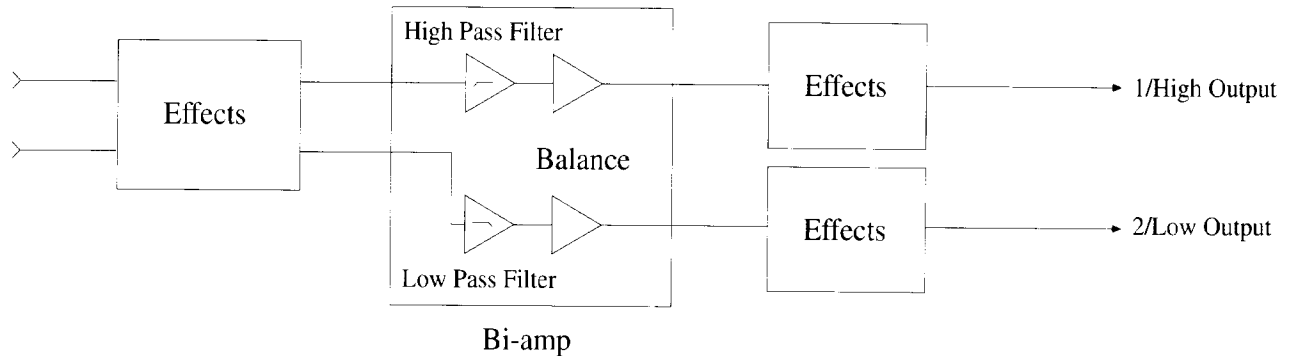

Parameters

- Mode:** There are two modes available; *Splitter* and *Bi-amp*. With *Splitter* only the balance can be adjusted.
- Balance:** Controls the right/left balance of the bi-amp output. This works like a stereo balance where the signal output from both sides is 100% at a balance of 50, at 0, 100% of the right signal is passed through and none of the left signal is passed, at 100, 100% of the left signal passes and none of the right signal is passed.
- High:** This is a high pass filter that allows frequencies higher than the specified frequency to pass. Range is 20 Hz to 3.3 kHz.
- Low:** This is a low pass filter that allows frequencies lower than the specified frequency to pass. Range is 20 Hz to 3.3 kHz.

APPENDIX B

SYSTEM EXCLUSIVE FORMAT

SYSEX Command Format

The following is the format for the System Exclusive dump and load requests:

F0 00 00 1B 09 03 rs ch cm nn data ... cksum (data ... cksum ...) F7

Where:

- rs = reserved for future use.
- ch = MIDI receive channel.
- cm = MIDI command. (See Table of Commands)
- nn = number of selected User Preset or Set. (Include only for Dump One Preset, Dump One Controller, or Dump Set requests. Do not include in Dump All Presets, Controllers, or Programs.)
- data = parameter data included only in load messages.
- cksum = modulo 128 checksum included only in load messages.

Note: For valid SYSEX DUMP requests, the data and checksum is not included.

Table of Commands

(Note: All numbers are in hexadecimal)

cm nn

- 00 nn Dump One Preset (nn = 00 - 7F)
- 02 nn Dump Preset Set (nn = 00 - 0B)
- 04 — Dump All Presets (nn not included)
- 06 nn Dump One Preset's Controllers (nn = 00 - 7F)
- 08 nn Dump Set's Controllers (nn = 00 - 0B)
- 0A — Dump All Continuous Controllers
- 0C — Dump All Programs
- 0E — Dump Edit Buffer

- | | |
|----------------------------------|---|
| Dump One Preset: | Dumps one presets' parameter data and continuous controllers. |
| Dump Preset Set: | Dumps ten presets' parameter data and continuous controllers. |
| Dump All Presets: | Dumps all 128 USER presets' parameter data, continuous controllers, and the program/volume map. |
| Dump One Preset's Controllers: | Dumps only the continuous controller data. |
| Dump Set's Controllers: | Dumps ten sets of continuous controllers. |
| Dump All Continuous Controllers: | Dumps 128 USER controller settings. |
| Dump All Programs: | Dumps the program/volume map. |
| Dump Edit Buffer: | Dumps contents of name, chain, parameter, and continuous controller from edit buffer. |

SYSEX Dump File Format

The following information is provided for programmers wishing to make use of SYSEX DUMP files to initialize remote editing software.

The first ten bytes transmitted in response to a dump one preset request is the SYSEX LOAD ONE PRESET header.

Following that, in nybbled form are ten NAME bytes. Next come ten nybbled bytes representing the effects chain.

Finally come 129 nybbled bytes representing the effect parameters. The format of this data is the same format used in the remote editing commands. The order of the effects and the number of bytes for each effect is as follows:

| | |
|---------------|----------|
| LEVELS: | 8 bytes |
| REVERB: | 8 bytes |
| OVERDRIVE: | 5 bytes |
| CHORUS: | 7 bytes |
| DELAY: | 8 bytes |
| COMPRESSOR: | 5 bytes |
| PITCH1: | 7 bytes |
| COIL TAP: | 2 bytes |
| SPEAKER SIM: | 1 byte |
| 5 BAND EQ: | 5 bytes |
| 3 BAND EQ: | 6 bytes |
| 2 BAND EQ: | 17 bytes |
| PAN: | 3 bytes |
| ENV. FILTER: | 5 bytes |
| EXCITER: | 5 bytes |
| CLASSIC EQ: | 4 bytes |
| NOISE GATE: | 4 bytes |
| DISTORTION: | 8 bytes |
| HUM FILTER: | 1 byte |
| STEREO SIM: | 3 bytes |
| PITCH2: | 7 bytes |
| EFFECTS LOOP: | 4 bytes |
| BI-AMP: | 6 bytes |

Then follow forty-one nybbled zeros (at the time of this printing). This is an expansion area for effects in future updates to the BASS-FEX.

Following that are forty nybbled bytes representing the eight continuous controller assignments. Once again, the format is the same as the remote editing format in **Appendix C**.

The last two bytes are the Modulo 128 checksum and the End Of Exclusive message.

DUMP ALL format:

During a SYSEX DUMP ALL, 128 presets are dumped each with its own modulo 128 checksum for error trapping during re-load. These are followed by the two PROGRAM MAPS.

APPENDIX C

REMOTE EDITING VIA SYSEX

The Sysex command is of the following format:

```
F0 00 00 1B 09 04 rs ch 10 fx_type pram datH datL (00 datH2 datL2) F7
```

where:

rs is reserved for future use.

ch is the MIDI channel number the unit is set to receive on.

fx_type is the effect indicator.

pram is the offset to the parameter.

datH datL is the first byte in nybble form.

00 indicates that this is a 2 byte variable (optional).

datH2 datL2 is the second byte in nybble form (optional).

Any parameter in the edit buffer can be remotely edited using the Remote Editing SYSEX commands. This includes the effects chain, effects levels, all effect parameters, the preset name, and the eight continuous controllers.

All remote editing changes are made to the preset in the EDIT buffer. User Presets will not be affected until the change is made permanent by storing it either remotely or from the front panel.

The REMOTE *Store* buffer command is of the following format:

```
F0 00 00 1B 09 04 rs ch 11 dest F7
```

where:

dest is the User preset storage location (0-127).

The following is a detailed look at the exact edit buffer locations being accessed by each FX_TYPE, PRAM pair:

FX_TYPE 0: Effect Chain

This is the command to edit the effect chain. Pram is a number between 0 and 7 which corresponds to the location of the effect in the chain. The data corresponds to each effect as follows:

(all numbers in hexadecimal)

Data

- 00 = End of Chain
- 01 = Compressor
- 02 = Distortion
- 03 = Overdrive
- 04 = Chorus
- 05 = Delay
- 06 = Pitch 1
- 07 = Pitch 2
- 08 = Reverb

- 09 = Classic EQ
- 0A = 5 Band Graphic Equalizer
- 0B = 3 Band Mid Sweep Equalizer
- 0C = 4 Band Parametric Equalizer
- 0D = Hum Filter
- 0E = Coil Tap
- 0F = Exciter
- 10 = Envelope Filter
- 11 = Pan
- 12 = Speaker Simulator
- 13 = Stereo Simulator
- 14 = Noise Gate
- 15 = Effects Loop
- 16 = Bi-amp
- FF = End of Left (top) path

IMPORTANT NOTE TO PROGRAMMERS: When adding a bi-amp to the chain, add the bi-amp at the desired location, then be sure to add an End of Left Path in the position following the last desired effect for the left path. Right path effects follow this marker. When deleting the bi-amp from the chain, the end of left path marker **MUST** be replaced with an End of Chain marker **BEFORE** replacing the bi-amp with another effect.

Effects can be added to the current end of the effect chain, or any existing effect can be changed to another type. Any attempt to add an effect beyond the end of the existing chain or to duplicate an existing effect will be ignored by the unit.

FX_TYPE 1: Compressor

This command allows remote access to the Compressor parameters. The data is stored as follows:

PRAM

- 0 = Attack Time
- 1 = Release Time
- 2 = Sustain
- 3 = Level
- 4 = Noise Gate Threshold (0-9 => 1-10)

FX_TYPE 2: Distortion

PRAM

- 0 = Drive
- 1 = Post Gain
- 2 = Fat (Bottom)
- 3 = Edge
- 4 = Body
- 5 = Shift
- 6 = Resonance (units) \ may be loaded as 1 byte or 2 bytes of data
- 7 = Resonance (tenths) /

FX_TYPE 3: Overdrive

PRAM

- 0 = LoRollOff (units) \may be loaded as 1 byte or 2 bytes of data
- 1 = LoRollOff (tenths) /
- 2 = PreDrive
- 3 = Clip Level
- 4 = Output Level

FX_TYPE 4: Chorus

PRAM

- 0 = Rate (units) \may be loaded as 1 byte or 2 bytes of data
- 1 = Rate (Tenths) /
- 2 = Depth
- 3 = Delay (units) \may be loaded as 1 byte or 2 bytes of data
- 4 = Delay (tenths) /
- 5 = Feedback (0-200 => -100 to +100)
- 6 = Mix (0-200 => -100 to +100)

FX_TYPE 5: Delay

PRAM

- 0 = Left (mono) Delay (low byte) \may be loaded as 1 byte or 2 bytes of data
- 1 = Left (mono) Delay (high byte) /
- 2 = Left (mono) Feedback
- 3 = Right Delay (low byte) \may be loaded as 1 byte or 2 bytes of data
- 4 = Right Delay (high byte) /
- 5 = Right feedback
- 6 = Mix (0-200 => -100 to +100)
- 7 = Tape Sim / Delay Type
(high nybble = tape sim freq, low nybble = delay type)

FX_TYPE 6: Pitch Shift 1

PRAM

- 0 = Pitch (0-24 => -12 to +12)
- 1 = Cents (0-100 => -50 to +50)
- 2 = Feedback
- 3 = Left Mix
- 4 = PreDelay Length
- 5 = Right Mix
- 6 = Input Pan (0=full right, 100=full left)

FX_TYPE 7: Pitch Shift 2

PRAM

- 0 = Pitch (0 - 24 => -12 to +12)
- 1 = Cents (0 - 100 => -50 to +50)
- 2 = Feedback
- 3 = Left Mix
- 4 = PreDelay Length
- 5 = Right Mix
- 6 = Input Pan (0 = full right, 100 = full left)

FX_TYPE 8: Reverb

PRAM

- 0 = Type
- 1 = Size
- 2 = Time (seconds) \may be loaded as 1 byte or 2 bytes of data
- 3 = Time (tenths) /
- 4 = Damping
- 5 = Mix
- 6 = Gated Reverb Time
- 7 = Pre-delay

FX_TYPE 9: Classic EQ

PRAM

- 0 = Low Gain
- 1 = Mid Gain
- 2 = Mid Shift
- 3 = High Gain

FX_TYPE \$A: 5 Band Graphic Equalizer

PRAM

- 0 = 100 Hz Gain (0 - 48 => -12 to +12 in .5 dB steps)
- 1 = 330 Hz Gain (0 - 48 => -12 to +12 in .5 dB steps)
- 2 = 1 kHz Gain (0 - 48 => -12 to +12 in .5 dB steps)
- 3 = 3 kHz Gain (0 - 48 => -12 to +12 in .5 dB steps)
- 4 = 10 kHz Gain (0 - 48 => -12 to +12 in .5 dB steps)

FX_TYPE \$B: 3 Band Mid Sweep Equalizer

PRAM

- 0 = Lo Gain (0 - 50)
- 1 = Mid Freq (mantissa) \may be loaded as 1 byte or 2 bytes of data
- 2 = Mid Freq (exponent) /
- 3 = Mid Gain (0 - 50)
- 4 = High Gain (0 - 50)
- 5 = Type

FX_TYPE \$C: 4 Band Parametric Equalizer

PRAM

- 0 = Band 1 Frequency (mantissa) \may be loaded as 1 byte or 2 bytes of data
- 1 = Band 1 Frequency (exponent) /
- 2 = Band 1 1/Bandwidth
- 3 = Band 1 Gain (0 - 72 => -24 to +12 in .5 dB steps)
- 4 = Band 2 Frequency (mantissa) \may be loaded as 1 byte or 2 bytes of data
- 5 = Band 2 Frequency (exponent) /
- 6 = Band 2 1/Bandwidth
- 7 = Band 2 Gain (0 - 72 => -24 to +12 in .5 dB steps)
- 8 = Band 3 Frequency (mantissa) \may be loaded as 1 byte or 2 bytes of data
- 9 = Band 3 Frequency (exponent) /
- A = Band 3 1/Bandwidth
- B = Band 3 Gain (0 - 72 => -24 to +12 in .5 dB steps)
- C = Band 4 Frequency (mantissa) \may be loaded as 1 byte or 2 bytes of data
- D = Band 4 Frequency (exponent) /
- E = Band 4 1/Bandwidth
- F = Band 4 Gain (0 - 72 => -24 to +12 in .5 dB steps)

FX_TYPE \$D: Hum Filter

PRAM

- 0 = Frequency (0 - 1 => 50 - 60 Hz)

FX_TYPE \$E: Coil Tap

PRAM

- 0 = Frequency
- 1 = Phase

FX_TYPE \$F: Exciter

PRAM

- 0 = Drive
- 1 = Tune (integer) \may be loaded as 1 byte or 2 bytes of data
- 2 = Tune (fraction) /
- 3 = Type
- 4 = Balance

FX_TYPE \$I0: Envelope Filter

PRAM

- 0 = Sensitivity
- 1 = Frequency
- 3 = Resonance
- 4 = Type
- 5 = Mix

FX_TYPE \$11: Auto Pan

PRAM

- 0 = Rate (units) \ may be loaded as 1 byte or 2 bytes of data
- 1 = Rate (tenths) /
- 2 = Depth

FX_TYPE \$12: Speaker Simulator

PRAM

- 0 = Type

FX_TYPE \$13: Stereo Simulator

PRAM

- 0 = Lowpass Filter (off/on)
- 1 = Tune
- 2 = Depth

FX_TYPE \$14: Noise Gate

PRAM

- 0 = Attack Time
- 1 = Release Time
- 2 = Threshold
- 3 = Sensitivity

FX_TYPE \$15: Effects Loop

PRAM

- 0 = Send Level
- 1 = Direct Level
- 2 = Return Level
- 3 = Summer

FX_TYPE \$16: Bi-amp

PRAM

- 0 = Mode
- 1 = Balance
- 2 = Highpass Freq (mantissa) \ may be loaded as 1 byte or 2 bytes of data
- 3 = Highpass Freq (exponent) /
- 4 = Lowpass Freq (mantissa) \ may be loaded as 1 byte or 2 bytes of data
- 5 = Lowpass Freq (exponent) /

FX_TYPE \$17: Name Buffer Edit

PRAM

Ten PRAMS each refer to a character position in the name buffer.

FX_TYPE \$18 - \$1F correspond to controllers 1 - 8. Each controller has five parameters; they are:

PRAM

- 0 = Effect type \ may be loaded as 1 byte or 2 bytes of data
- 1 = Effect parameter /
- 3 = Continuous Controller Number (1-128)
- 4 = Channel 0 - 16 (16 is Omni)
- 5 = Scale Factor (-100 - 100)

These Effect type/Parameter Pairs are identical to the pairs listed above. Each of the 2 byte parameters are referenced by the first PRAM of the pair. Some effects parameters do not have controllers available. An error message will appear if an unused FX_TYPE/Parameter pair is sent.

FX_TYPE \$20: Effect Levels

PRAM

- 0 = Effect 1 level
- 1 = Effect 2 level
- 2 = Effect 3 level
- 3 = Effect 4 level
- 4 = Effect 5 level
- 5 = Effect 6 level
- 6 = Effect 7 level
- 7 = Effect 8 level

SPECIFICATIONS

Frequency Response

15 Hz to 19 kHz +1, -2 dB

10 Hz to 20 kHz +1, -3dB

Total Harmonic Distortion

Less than 0.02% at 1 kHz

Signal-to-Noise Ratio

90 dB

Input and Output Jacks

1/4 inch single-ended

Input Impedance

220 K ohms

Maximum Input Gain

43.5 dB

Maximum Output Level

11.0 dBu (600 ohms)

12.5 dBu (Hi-Z)

A/D Conversion

Rate: 44.1 kHz

Quantization: 16 bit

64x Oversampled

D/A Conversion

Rate: 44.1 kHz

Quantization: 16 bit

Presets/Programs

256 presets (128 user, 128 factory)

mappable to 256 programs

(optional Cartridge adds 128 more presets and 128 more programs)

MIDI

MIDI In, MIDI Thru/Out

Simultaneous Effects

Up to 8 maximum (any order)

Effect Types

Compressor

Chorus

Delay:

Stereo: 360 ms per channel maximum

Tapped: 724 ms per channel maximum

Mono: 724 ms per channel maximum

Auto Pan

Pitch Shift 1: One octave up or down maximum

Pitch Shift 2: One octave up or down maximum

Reverb:

Plate

Spring

Tunnel

Room

Stage

Hall

Gated

Reverse Gated

Coil Tap

Exciter

Envelope Filter

5 Band Graphic Equalizer

3 Band Sweep Mid Equalizer

4 Band Parametric Equalizer

Hum Filter

Speaker Simulation:

Scorpion Open Backed

Scorpion Closed Backed

412 Cabinet

British

Distortion

Overdrive

Classic (guitar) Equalizer

Noise Gate

Stereo Simulator

Bi-amp

Effects Loop

User Interface

20 character by 2 line LCD

10 push-buttons

Data knob

Dimensions

Width: 19.000"

Depth: 8.375"

Height: 1.750"

Weight: 5 pounds

Power Supply Requirements

16.5 V AC 1 amp

MIDI Implementation Chart

Date: 4/92

Model: BASS-FEX

Version: 1.0

| Function | Transmitted | Recognized | Remarks |
|--|------------------|------------------|--|
| Basic Default Channel Channel | 1 - 16 | 1 - 16 | Memorized |
| Mode Default Messages Altered | 3 X X | 1,3 X X | |
| Note Number True Voice | X | O | MIDI Dynamic Effects Controller |
| Velocity Note On Note Off | X X | X X | |
| After Touch Key's Ch's | X X | O X | MIDI Dynamic Effects Controller |
| Pitch Bender | X | O | MIDI Dynamic Effects Controller |
| Control Change | X | 0 - 120 | MIDI Dynamic Effects Controller Controller #91 - Bypass |
| Prog Change True# | 0 - 127 | 0 - 127 | |
| System Exclusive | O | O | |
| System : Songs Pos : Song Sel Common: Tune | X X X | X X X | |
| System : Clock Real Time Commands | X X | O X | Sync Delay |
| Aux :Local ON/OFF Mes- : All Notes Off sages : Active Sense : Reset | X X X X | X X X X | |
| Notes | | | |

Mode 1 : OMNI ON, POLY
Mode 3 : OMNI OFF, POLY

Mode 2 : OMNI ON, MONO
Mode 4 : OMNI OFF, MONO

O : Yes
X : No

THIS LIMITED WARRANTY VALID ONLY WHEN PURCHASED AND REGISTERED IN THE UNITED STATES OR CANADA. ALL EXPORTED PRODUCTS ARE SUBJECT TO WARRANTY AND SERVICES TO BE SPECIFIED AND PROVIDED BY THE AUTHORIZED DISTRIBUTOR FOR EACH COUNTRY.

Ces clauses de garantie ne sont valables qu'aux Etats-Unis et au Canada. Dans tous les autres pays, les clauses de garantie et de maintenance sont fixées par le distributeur national et assurées par lui selon la législation en vigueur.

Diese Garantie ist nur in den USA und Kanada gültig. Alle Export-Produkte sind der Garantie und dem Service des Importeurs des jeweiligen Landes unterworfen. Esta garantía es válida solamente cuando el producto es comprado en E.U. continentales o en Canada. Todos los productos que sean comprados en el extranjero, están sujetos a las garantías y servicio que cada distribuidor autorizado determine y ofrezca en los diferentes países.

PEAVEY ONE-YEAR LIMITED WARRANTY/REMEDY

PEAVEY ELECTRONICS CORPORATION ("PEAVEY") warrants this product, EXCEPT for covers, footswitches, patchcords, tubes and meters, to be free from defects in material and workmanship for a period of one (1) year from date of purchase, PROVIDED, however, that this limited warranty is extended only to the original retail purchaser and is subject to the conditions, exclusions, and limitations hereinafter set forth:

PEAVEY 90-DAY LIMITED WARRANTY ON TUBES AND METERS

If this product contains tubes or meters, Peavey warrants the tubes or meters contained in the product to be free from defects in material and workmanship for a period of ninety (90) days from date of purchase; PROVIDED, however, that this limited warranty is extended only to the original retail purchaser and is also subject to the conditions, exclusions, and limitations hereinafter set forth.

CONDITIONS, EXCLUSIONS, AND LIMITATIONS OF LIMITED WARRANTIES

These limited warranties shall be void and of no effect, if:

- a. The first purchase of the product is for the purpose of resale; or
- b. The original retail purchase is not made from an AUTHORIZED PEAVEY DEALER; or
- c. The product has been damaged by accident or unreasonable use, neglect, improper service or maintenance, or other causes not arising out of defects in material or workmanship; or
- d. The serial number affixed to the product is altered, defaced, or removed.

In the event of a defect in material and/or workmanship covered by this limited warranty, Peavey will:

- a. In the case of tubes or meters, replace the defective component without charge.
- b. In other covered cases (i.e., cases involving anything other than covers, footswitches, patchcords, tubes or meters), repair the defect in material or workmanship or replace the product, at Peavey's option; and provided, however, that, in any case, all costs of shipping, if necessary, are paid by you, the purchaser.

THE WARRANTY REGISTRATION CARD SHOULD BE ACCURATELY COMPLETED AND MAILED TO AND RECEIVED BY PEAVEY WITHIN FOURTEEN (14) DAYS FROM THE DATE OF YOUR PURCHASE.

In order to obtain service under these warranties, you must:

- a. Bring the defective item to any PEAVEY AUTHORIZED DEALER or AUTHORIZED PEAVEY SERVICE CENTER and present therewith the ORIGINAL PROOF OF PURCHASE supplied to you by the AUTHORIZED PEAVEY DEALER in connection with your purchase from him of this product. If the DEALER or SERVICE CENTER is unable to provide the necessary warranty service you will be directed to the nearest other PEAVEY AUTHORIZED DEALER or AUTHORIZED PEAVEY SERVICE CENTER which can provide such service.

OR

- b. Ship the defective item, prepaid, to:

PEAVEY ELECTRONICS CORPORATION
International Service Center
326 Hwy. 11 & 80 East
MERIDIAN, MS 39301

including therewith a complete, detailed description of the problem, together with a legible copy of the original PROOF OF PURCHASE and a complete return address. Upon Peavey's receipt of these items:

If the defect is remedial under these limited warranties and the other terms and conditions expressed herein have been complied with, Peavey will provide the necessary warranty service to repair or replace the product and will return it, FREIGHT COLLECT, to you, the purchaser.

Peavey's liability to the purchaser for damages from any cause whatsoever and regardless of the form of action, including negligence, is limited to the actual damages up to the greater of \$500.00 or an amount equal to the purchase price of the product that caused the damage or that is the subject of or is directly related to the cause of action. Such purchase price will be that in effect for the specific product when the cause of action arose. This limitation of liability will not apply to claims for personal injury or damage to real property or tangible personal property allegedly caused by Peavey's negligence. Peavey does not assume liability for personal injury or property damage arising out of or caused by a non-Peavey alteration or attachment, nor does Peavey assume any responsibility for damage to interconnected non-Peavey equipment that may result from the normal functioning and maintenance of the Peavey equipment.

UNDER NO CIRCUMSTANCES WILL PEAVEY BE LIABLE FOR ANY LOST PROFITS, LOST SAVINGS, ANY INCIDENTAL DAMAGES, OR ANY CONSEQUENTIAL DAMAGES ARISING OUT OF THE USE OR INABILITY TO USE THE PRODUCT, EVEN IF PEAVEY HAS BEEN ADVISED OF THE POSSIBILITY OF SUCH DAMAGES.

THESE LIMITED WARRANTIES ARE IN LIEU OF ANY AND ALL WARRANTIES, EXPRESSED OR IMPLIED, INCLUDING, BUT NOT LIMITED TO, THE IMPLIED WARRANTIES OF MERCHANTABILITY AND FITNESS FOR A PARTICULAR USE; PROVIDED, HOWEVER, THAT IF THE OTHER TERMS AND CONDITIONS NECESSARY TO THE EXISTENCE OF THE EXPRESSED, LIMITED WARRANTIES, AS HEREINABOVE STATED, HAVE BEEN COMPLIED WITH, IMPLIED WARRANTIES ARE NOT DISCLAIMED DURING THE APPLICABLE ONE-YEAR OR NINETY-DAY PERIOD FROM DATE OF PURCHASE OF THIS PRODUCT.

SOME STATES DO NOT ALLOW LIMITATION ON HOW LONG AN IMPLIED WARRANTY LASTS, OR THE EXCLUSION OR LIMITATION OF INCIDENTAL OR CONSEQUENTIAL DAMAGES, SO THE ABOVE LIMITATIONS OR EXCLUSIONS MAY NOT APPLY TO YOU. THESE LIMITED WARRANTIES GIVE YOU SPECIFIC LEGAL RIGHTS, AND YOU MAY ALSO HAVE OTHER RIGHTS WHICH MAY VARY FROM STATE TO STATE.

THESE LIMITED WARRANTIES ARE THE ONLY EXPRESSED WARRANTIES ON THIS PRODUCT, AND NO OTHER STATEMENT, REPRESENTATION, WARRANTY, OR AGREEMENT BY ANY PERSON SHALL BE VALID OR BINDING UPON PEAVEY.

In the event of any modification or disclaimer of expressed or implied warranties, or any limitation of remedies, contained herein conflicts with applicable law, then such modification, disclaimer or limitation, as the case may be, shall be deemed to be modified to the extent necessary to comply with such law.

Your remedies for breach of these warranties are limited to those remedies provided herein and Peavey Electronics Corporation gives this limited warranty only with respect to equipment purchased in the United States of America.

INSTRUCTIONS — WARRANTY REGISTRATION CARD

1. Mail the completed WARRANTY REGISTRATION CARD to:

PEAVEY ELECTRONICS CORPORATION
POST OFFICE BOX 2898
MERIDIAN, MISSISSIPPI 39302-2898

- a. Keep the PROOF OF PURCHASE. In the event warranty service is required during the warranty period, you will need this document. There will be no identification card issued by Peavey Electronics Corporation.
2. IMPORTANCE OF WARRANTY REGISTRATION CARDS AND NOTIFICATION OF CHANGES OF ADDRESSES:
 - a. Completion and mailing of WARRANTY REGISTRATION CARDS — Should notification become necessary for any condition that may require correction, the REGISTRATION CARD will help ensure that you are contacted and properly notified.
 - b. Notice of address changes — If you move from the address shown on the WARRANTY REGISTRATION CARD, you should notify Peavey of the change of address so as to facilitate your receipt of any bulletins or other forms of notification which may become necessary in connection with any condition that may require dissemination of information or correction.
3. You may contact Peavey directly by telephoning (601) 483-5365.

IMPORTANT SAFETY INSTRUCTIONS

WARNING: When using electric products, basic cautions should always be followed, including the following.

1. Read all safety and operating instructions before using this product.
2. All safety and operating instructions should be retained for future reference.
3. Obey all cautions in the operating instructions and on the back of the unit.
4. All operating instructions should be followed.
5. This product should not be used near water, i.e., a bathtub, sink, swimming pool, wet basement, etc.
6. This product should be located so that its position does not interfere with its proper ventilation. It should not be placed flat against a wall or placed in a built-in enclosure that will impede the flow of cooling air.
7. This product should not be placed near a source of heat such as a stove, radiator, or another heat producing amplifier.
8. Connect only to a power supply of the type marked on the unit adjacent to the power supply cord.
9. Never break off the ground pin on the power supply cord. For more information on grounding, write for our free booklet "Shock Hazard and Grounding."
10. Power supply cords should always be handled carefully. Never walk or place equipment on power supply cords. Periodically check cords for cuts or signs of stress, especially at the plug and the point where the cord exits the unit.
11. The power supply cord should be unplugged when the unit is to be unused for long periods of time.
12. If this product is to be mounted in an equipment rack, rear support should be provided.
13. Metal parts can be cleaned with a damp rag. The vinyl covering used on some units can be cleaned with a damp rag or an ammonia-based household cleaner if necessary. Disconnect unit from power supply before cleaning.
14. Care should be taken so that objects do not fall and liquids are not spilled into the unit through the ventilation holes or any other openings.
15. This unit should be checked by a qualified service technician if:
 - a. The power supply cord or plug has been damaged.
 - b. Anything has fallen or been spilled into the unit.
 - c. The unit does not operate correctly.
 - d. The unit has been dropped or the enclosure damaged.
16. The user should not attempt to service this equipment. All service work should be done by a qualified service technician.
17. This product should be used only with a cart or stand that is recommended by Peavey Electronics.
18. Exposure to extremely high noise levels may cause a permanent hearing loss. Individuals vary considerably in susceptibility to noise induced hearing loss, but nearly everyone will lose some hearing if exposed to sufficiently intense noise for a sufficient time. The U.S. Government's Occupational Safety and Health Administration (OSHA) has specified the following permissible noise level exposures.

| Duration Per Day In Hours | Sound Level dBA, Slow Response |
|---------------------------|--------------------------------|
| 8 | 90 |
| 6 | 92 |
| 4 | 95 |
| 3 | 97 |
| 2 | 100 |
| 1 1/2 | 102 |
| 1 | 105 |
| 1/2 | 110 |
| 1/4 or less | 115 |

According to OSHA, any exposure in excess of the above permissible limits could result in some hearing loss.

Ear plugs or protectors in the ear canals or over the ears must be worn when operating this amplification system in order to prevent a permanent hearing loss if exposure is in excess of the limits as set forth above. To ensure against potentially dangerous exposure to high sound pressure levels, it is recommended that all persons exposed to equipment capable of producing high sound pressure levels such as this amplification system be protected by hearing protectors while this unit is in operation.

SAVE THESE INSTRUCTIONS!



Features and specifications subject to change without notice.

Peavey Electronics Corporation 711 A Street / Meridian, MS 39301 / U.S.A. / (601) 483-5365 / Fax 486-1278